

Railway products

Edition 2017/09



Bridging our technologies





Interdisciplinary knowledge

The HUBER+SUHNER Group is a leading international manufacturer of electrical and optical interconnectivity components and systems. Our main markets are communication, transport and industry. Under one roof, we combine technological capabilities in the three core fields of Radio Frequency (RF), Fiber Optics (FO) and Low Frequency (LF). As one of Europe's leading suppliers, HUBER+SUHNER offers a wide range of products which provides the platform to build modern rail vehicles. New and innovative products based on our proven technologies support you to fulfil the demanding requirements of the railway industry.

Railway products overview

Engineering services	7
LF traction cables	9
Cable systems	145
Wireless communication	153
RF railway cables and connectors	163
RF trackside products	186
Fiber optic solutions	191
Additional information	199



Engineering services

Our years of experience in the field of Rail enable us to offer our customers individualised solution packages which – in addition to the selection of the most suitable products – also include the related services.

We are proud of the smooth collaboration with our customers, with whose assistance we continuously further develop our products. Our services are designed to make it easier for our customers to apply our components.

Design support

- Creation of customer-specific solutions by our applications engineers
- Determination and definition of customer-specific products
- Exchange of CAD data for ensuring optimal design-in of our components in our customers' systems
- Investigation of special effects in the application of our products
- Environmental tests in our in-house test facilities

Project development

- Project management
- Materials planning, compilation of component kits
- Assistance during installation

Training

- Local on-site product training courses by our specialists
- Individual compiled workshops



SOB

526 041-9

3/4

RADOX® traction cables

RADOX traction cables	10
RADOX railway cables – selection table	14
RADOX EN 50306 family (600 to 500 V) single cores and multi cores	17
RADOX TENUIS-TW family (600/1000 V) single cores	36
multi cores	38
multi cores, screened	40
RADOX GWK-LW family (600/1000 V) single cores	44
multi cores	46
multi cores, screened	48
RADOX 3 GWK family (600/1000 V) single cores	52
multi cores	54
multi cores, screened	56
RADOX 4 GWK-AX family (1800/3000 V) single cores	60
single and multi cores, screened	62, 64
RADOX 4 GWK-AX J family (1800/3000 V) single cores	68
RADOX 9 GWK-AX family (3600/6000 V) single cores	72
single and multi cores, screened	74, 76
RADOX EN 50264 family (600 to 3600 V) single cores and multi cores	79
RADOX Jumper cables single and multi cores	93
RADOX Databus cables	109
RADOX FR cables single and multi cores	127
Fire safety requirements	142

RADOX[®] traction cables

What does RADOX mean?

The HUBER+SUHNER registered trademark RADOX[®] stands for electron-beam crosslinked insulation materials. RADOX insulation materials deliver outstanding resistance to thermal, chemical, electrical and mechanical loads.

The advantages of RADOX materials

RADOX materials do not melt, even at extremely high temperatures, and retain dimensional stability in the event of a short circuit.

Due to their superlative insulating properties, RADOX railway cables do not need thick walls. This greatly reduces the amount of space required and the cable weight.

The RADOX railway cable range has been tested successfully in accordance with European cable standards EN 50264 and EN 50306, as well as standards GOST 20.57.406-81, Method 204-1 and GOST 17491-80. This gives customers an additional safety factor.

Temperature range of RADOX traction cables

-50 tested in Russian laboratories
+120 °C with a service life of 20 000 hours

Insulation and sheath materials compliant with European cable standards

The European cable standards impose demanding requirements with regard to mechanical, thermal, chemical and fire safety properties. The fire safety stipulations are described in the cable standards EN 50264 and EN 50306, as well as in fire safety standard EN 45545-2.

The halogen-free, electron-beam crosslinked RADOX materials meet the highest requirements (M) for each standard and the hazard level (HL3).

Properties

- Particularly low temperature
- Particularly oil-resistant
- Particularly fuel-resistant

Requirements

-40 °C
IRM 902, 24 hrs/72 hrs, 100 °C (duration dependent on cable standard, 24 hrs = EN 50306-2)
IRM 903, 168 hrs, 70 °C

Assignment of hazard levels (HL) in acc. with EN 45545-2

Operation categories		Design categories	N	A	D	S
			Standard vehicles	Automatic vehicles	Double decked vehicles	Sleeping cars
1	No underground sections Immediate evacuation possible		HL 1	HL 1	HL 1	HL 2
2	With underground sections Evacuation within a short time possible		HL 2	HL 2	HL 2	HL 2
3	With underground sections Evacuation within a long time possible		HL 2	HL 2	HL 2	HL 3
4	With underground sections Without side evacuation		HL 3	HL 3	HL 3	HL 3

RADOX[®] traction cables

As one of the leading providers of standard and customer-specific cables and cable systems, HUBER+SUHNER delivers the optimum solution for the wiring of rail vehicles such as regional trains, high-speed trains, underground railways, trams and locomotives.

Its many years of experience in the rail sector give customers the reassuring knowledge that, with HUBER+SUHNER, they will receive innovative products that work perfectly.

RADOX railway cables meet the demanding requirements of the rail market by virtue of the following key properties:

- Enhanced fire safety
- Enhanced mechanical resistance
- Enhanced media resistance
- Enhanced temperature range
- Secure signal and power transmission
- Weight reduction
- Space reduction
- Lower service cycle costs

The global sales organisation guarantees an on-site presence and local support.

RADOX[®] traction cables

RADOX cable code (example)

HUBER+SUHNER labels its traction cables in accordance with cable standards EN 50264 and EN 50306.

Labelling examples

HUBER+SUHNER	RADOX	4 GWK-AX	1800 V	3 × 2.5	MM	12564186	7654321
1	2	3	6	7	8 9	12	13

HUBER+SUHNER	RADOX	EN 50306-4	3 P	300 V	4 × 0.75	MM	S	90	12564186	7654321	Date of production
1	2	3	4 5	6	7	8 9	10	11	12	13	14

Description

1. Name of producer	HUBER+SUHNER
2. Registered brand of HUBER+SUHNER	RADOX [®]
3. Name of cable familia	4 GWK-AX oder EN 50306 oder 3 GWK ...
4. Construction according to table in EN 50306-standard	1. unscreened; 3. screened; 5. pairs screened
5. Installation of the cable	P: protected installation; E: unprotected installation
6. Voltage rating	V AC
7. Number of cores and conductor nominal cross section	(mm ²)
8. Hazard level for insulation	M
9. Hazard level for sheath	M
10. Screen	S
11. Nominal temperature	°C only for EN 50306 cores/cables
12. Item no.	
13. Production number	
14. Date of production	ww-yyyy (optional)

RADOX® railway cables – selection table

Voltage	RADOX® cable family	Cross section	Number of cores	Temperature range	Single core	
		mm ²			°C	un-screened
300/500 V AC	EN 50306-2	0.5 - 2.5	1	-40 to +120	X	
	EN 50306-3	0.5 - 2.5	1 - 4	-40 to +120		X
	EN 50306-4 1P	0.5 - 2.5	2 - 48	-40 to +120		
	EN 50306-4 1E					
	EN 50306-4 3P	0.5 - 2.5	2 - 8	-40 to +120		
	EN 50306-4 3E					
	EN 50306-4 5P	0.5 - 1.5	2 - 7 pairs	-40 to +120		
	EN 50306-4 5E					
	3 GKW 300V M FR RW	1 - 2.5	1	-50 to +120	X	
	3 GKW 300V MM FR RW	0.5 - 2.5	2 - 25			
	3 GKW 300V MM S FR RW	0.5 - 2.5	2 - 20			
600/1000 V AC	TENUIS-TW 600V M	0.5 - 4.0	1	-50 to +120	X	
	TENUIS-TW 600V MM	0.5 - 4.0	2 - 95			
	TENUIS-TW 600V MM S	0.5 - 4.0	2 - 95			
	GKW-LW 600V M	0.5 - 2.5	1	-50 to +120	X	
	GKW-LW 600V MM	0.5 - 2.5	2 - 50			
	GKW-LW 600V MM S	0.5 - 2.5	2 - 50			
	3 GKW 600V	0.5 - 400	1	-50 to +120	X	
	3 GKW 600V XM	0.5 - 35	2 - 50			
	3 GKW 600V XM S	0.5 - 50	2 - 50			
	EN 50264-3-1 600V M	1 - 400	1	-50 to +120	X	
	EN 50264-3-2 600V MM	1.5 - 50	2 - 4			
	EN 50264-3-2 600V MM S	1.5 - 50	2 - 4			
	3 GKW 600V FR	1 - 50	1	-50 to +120	X	
	3 GKW 600V XM FR	1.5 - 50	3 - 7			
1800/3000 V AC	4 GKW-AX 1800V M	0.5 - 400	1	-50 to +120	X	
	4 GKW-AX 1800V MM S	1.5 - 400	1			X
	4 GKW-AX 1800V MM S	1.5 - 95	2 - 20			
	EN 50264-3-1 1800V M	1.5 - 400	1	-50 to +120	X	
	EN 50264-3-1 1800V MM				X	
	4 GKW-AX 1800V M J	16 - 300	1	-50 to +120	X	
	4 GKW-AX 1800V M FR	1.5 - 240	1	-50 to +120	X	
3600/6000 V AC	9 GKW-AX 3600V M	1.5 - 300	1	-50 to +120	X	
	9 GKW-AX 3600V MM S	1.5 - 300	1			X
	9 GKW-AX 3600V MM S	1.5 - 300	2			
	EN 50264-3-1 3600V MM	2.5 - 400	1	-50 to +120		

	With additional sheath	Multi core		Multipair	Installation		Insulation		Detailed information
		un-screened	screened		protected	exposed	thin wall	reduced wall	
							X		18
			X		X		X		20
		X			X		X		22
		X				X	X		24
			X		X		X		26
			X			X	X		28
				X	X		X		30
				X		X	X		32
							X		126
		X					X		128
			X				X		130
							X		36
		X		X			X		38
			X	X			X		40
							X		44
		X		X			X		46
			X	X			X		48
								X	52
		X		X				X	54
			X	X				X	56
								X	80
		X						X	88
			X					X	90
								X	132
		X						X	134
								X	60
								X	62
			X					X	64
								X	82
	X							X	84
					X			X	68
								X	138
								X	72
								X	74
			X						76
	X							X	86

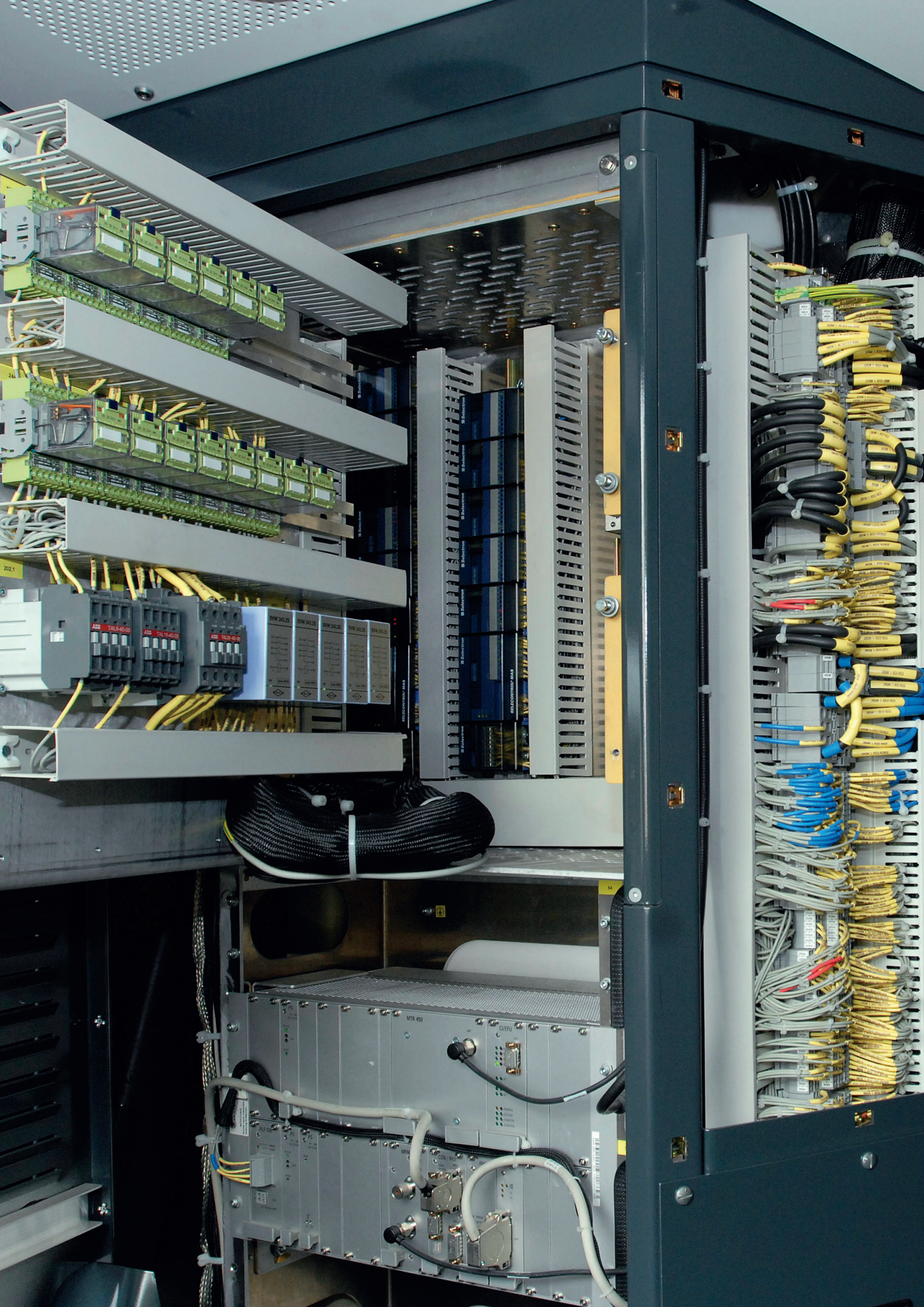









RADOX® EN 50306 family

Cables and cores for rolling stock

- With voltage rating 300/500 V AC
- With improved behaviour in case of fire
- With thin wall isolation

The new RADOX EN 50306 railway cables are based on the recently developed, halogen-free, electron-beam crosslinked insulation system RADOX EI 306 with the sheath material RADOX EM 104, and comply with the specifications of standard EN 50306 (hazard level: HL3; property level: M).

Product range overview

• EN 50306-2	single core page 18	
• EN 50306-3	single and multi core (pairs, triples, quads) screened with thin wall sheathed page 20 - 21	
• EN 50306-4 P	multi core and multipair cables, protected installation	
1P	unscreened, page 22	
3P	with overall screen, page 26	
5P	pairs, single screened, sheathed and overall sheath, page 30	
• EN 50306-4 E	multi core and multipair cables, exposed installation (same construction as EN 50306-4 P but with enhanced sheath)	
1E	unscreened, page 24	
3E	with overall screen and overall sheath, page 28	
5E	pairs, single screened, sheathed and overall sheath, page 32	

All cores and cables have tin-plated stranded copper conductors and halogen-free insulation sheaths and materials. The cores and cables are designed for unprotected installation (Class E) or for protected installation (Class P). They are intended for permanent installation in rail vehicles or for applications in which a limited alternating bending stress occurs during service.

RADOX® EN 50306-2 300V M

single core

Conductor	according to EN 50306-2	Voltage rating	300/500 V AC
Number of conductors	1		410 V DC
Cross section	0.5 - 2.5 mm ²	Temperature range	-40 to +125 °C

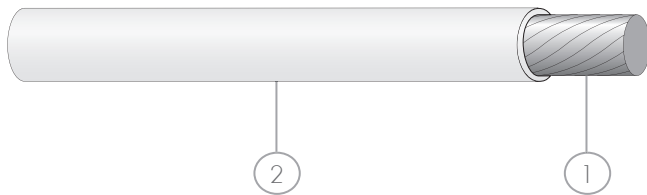

Composition of cable

1. Conductor	stranded tin plated copper
2. Insulation	RADOX EI 306 colours: white or green-yellow

Characteristics

- Electron beam crosslinked insulation
- Halogen free
- Flame retardant
- Best electrical performance
- Excellent resistance to high and low temperature
- Resistance to oil, ozone and weathering
- Flexible
- Easy to strip

Standards

Standard	Fire protection on railway vehicles	
DIN 5510-2	category	1, 2, 3, 4
EN 45545-2		
NF F 16-101	class, category	C/F0, int. A1, A2, B/ext. A1, A2, B
NFPA 130		
UNI CEI 11170-3		

For further technical details please refer to our data sheet.

RADOX® EN 50306-2 300V M

single core

Core cross section	Conductor		Core	Conductor resistance	Capacitance*	Fire load	Weight		Colours	Item no.
	mm ²	Constr. n × mm					D _{nom.} mm	D mm		
0.5	19 × 0.18	0.88	1.42 ± 0.03	40.1	356	37	0.45	0.6	WH	12586000
0.75	19 × 0.23	1.09	1.62 ± 0.03	26.7	430	43	0.69	0.9	WH GNYE	12586001 12586002
1	19 × 0.26	1.23	1.77 ± 0.03	20.0	470	50	0.88	1.1	WH	12586003
1.5	19 × 0.31	1.49	2.17 ± 0.03	13.7	459	74	1.3	1.6	WH GNYE	12586004 12586007
2.5	19 × 0.40	1.94	2.75 ± 0.05	8.21	509	113	2.2	2.6	WH GNYE	12586005 12586006

* capacity in water, typical value

M: material designation according to EN 50306-1

Use of RADOX EN 50306-2 cores in following cables:

- RADOX EN 50306-3 300 V
- RADOX EN 50306-4 1P/1E 300 V
- RADOX EN 50306-4 3P/3E 300 V
- RADOX EN 50306-4 5P/5E 300

RADOX® EN 50306-3 300V MM S

Conductor	according to EN 50306-2	Voltage rating	300/500 V AC
Number of conductors	1 - 4		450 V DC
Cross section	0.5 - 2.5 mm ²	Temperature range	-50 to +120 °C



Composition of cable

1. Conductor	stranded, tin plated copper
2. Insulation	RADOX EI 306 colours: white or green-yellow
3. Screen	copper braid
4. Sheat	RADOX S2 colour: black

Characteristics

- Electron beam crosslinked insulation
- Halogen free
- Flame retardant
- Best electrical performance
- Excellent resistance to high and low temperature
- Resistance to oil, ozone and weathering
- Flexible
- Easy to strip

Application

- For mechanically protection installation

Standards

Standard	Fire protection on railway vehicles
DIN 5510-2	category 1, 2, 3, 4
EN 45545-2	
GOST 31565	
NFF 16-101	class, category C/F0, int. A1, A2, B/ext. A1, A2, B
UNI CEI 11170-3	

For further technical details please refer to our data sheet.

single core, screened

Core cross section	Conductor		Core	Screen		Cable	Conductor resistance	Z_T	Fire load	Weight		Item no.
$n \times \text{mm}^2$	Constr. $n \times \text{mm}$	$D_{\text{nom.}}$ mm	$D_{\text{nom.}}$ mm	$D_{\text{nom.}}$ mm	$D_{\text{nom.}}$ mm^2	D mm	R_{20} max. Ω/km	max. $\text{m}\Omega/\text{m}$	nom. kJ/m	Copper $\text{kg}/100 \text{ m}$	Cable $\text{kg}/100 \text{ m}$	
0.5	19 × 0.18	0.88	1.42	1.9	0.52	2.65 ± 0.2	40.1	320	125	1	1.5	84097978
0.75	19 × 0.23	1.09	1.62	2.1	0.52	2.70 ± 0.2	26.7	320	120	1.2	1.7	84111017
1	19 × 0.26	1.23	1.77	2.3	0.52	2.85 ± 0.2	20.0	280	130	1.4	1.9	84097980
1.5	19 × 0.31	1.49	2.17	2.7	0.65	3.30 ± 0.2	13.7	260	175	2	2.7	84111019
2.5	19 × 0.40	1.94	2.75	3.2	0.78	3.90 ± 0.2	8.21	200	235	3	3.9	84111020

MM: insulation and sheath material designation according to EN 50306-1

S: metallic screen braid

RADOX® EN 50306-4 1P 300V MM

Conductor	according to EN 50306-2	Voltage rating	300/500 V AC
Number of conductors	2 - 48		450 V DC
Cross section	0.5 - 2.5 mm ²	Temperature range	-40 to +120 °C

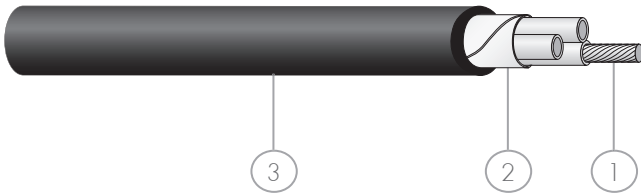

Composition of cable

1. Cores EN 50306-2	conductor insulation colour	stranded, tin plated copper RADOX EI 306 white, numbered or green-yellow
2. Separator	tape	
3. Sheath	RADOX EM 104 colour: black	

Characteristics

- Electron beam crosslinked insulation
- Halogen free
- Flame retardant
- Best electrical performance
- Excellent resistance to high and low temperature
- Resistance to oil, ozone and weathering
- Flexible
- Easy to strip

Application

- For mechanically protection installation

Standards

Standard	Fire protection on railway vehicles	
DIN 5510-2	category	1, 2, 3, 4
EN 45545-2		
NFF 16-101	class, category	C/F0, int. A1, A2, B/ext. A1, A2, B
UNI CEI 11170-3		

For further technical details please refer to our data sheet.

Cable type	Conductor		Core	Cable	Conductor resistance	Fire load	Weight		Item no.
$n \times \text{mm}^2$	Constr. $n \times \text{mm}$	$D_{\text{nom.}}$ mm	$D_{\text{nom.}}$ mm	D mm	$R_{20} \text{ max.}$ Ω/km	nom. kJ/m	Copper kg/100 m	Cable kg/100 m	
4 × 0.5	19 × 0.18	0.88	1.42	4.9 ± 0.2	40.1	370	1.8	4.2	12586008
7 × 0.5	19 × 0.18	0.88	1.42	5.6 ± 0.3	40.1	490	3.2	6.1	12586009
13 × 0.5	19 × 0.18	0.88	1.42	8.0 ± 0.3	40.1	940	5.9	11.6	12586010
19 × 0.5	19 × 0.18	0.88	1.42	8.8 ± 0.3	40.1	1210	8.7	15.8	12586011
37 × 0.5	19 × 0.18	0.88	1.42	11.6 ± 0.4	40.1	2000	16.9	27.8	12586012
4 × 0.75	19 × 0.23	1.09	1.62	5.4 ± 0.2	26.7	440	2.8	5.6	12586013
4 G 0.75	19 × 0.23	1.09	1.62	5.4 ± 0.2	26.7	440	2.8	5.6	12586014
7 × 0.75	19 × 0.23	1.09	1.62	6.2 ± 0.3	26.7	590	4.9	8.4	12586015
7 G 0.75	19 × 0.23	1.09	1.62	6.2 ± 0.3	26.7	590	4.9	8.4	12586016
13 × 0.75	19 × 0.23	1.09	1.62	8.9 ± 0.3	26.7	1130	9.1	15.9	12586017
19 × 0.75	19 × 0.23	1.09	1.62	9.9 ± 0.3	26.7	1430	13.3	21.5	12586018
37 × 0.75	19 × 0.23	1.09	1.62	13.1 ± 0.3	26.7	2440	26	39.1	12586019
48 × 0.75	19 × 0.23	1.09	1.62	15.1 ± 0.4	26.7	3110	33.7	50.4	12586020
3 × 1	19 × 0.26	1.23	1.77	5.25 ± 0.3	20.0	395	2.7	5.3	85006857
4 × 1	19 × 0.26	1.23	1.77	5.7 ± 0.2	20.0	460	3.6	6.5	12586021
7 × 1	19 × 0.26	1.23	1.77	6.7 ± 0.3	20.0	645	6.3	10.1	12586022
13 × 1	19 × 0.26	1.23	1.77	9.6 ± 0.3	20.0	1250	11.7	19.2	12586023
19 × 1	19 × 0.26	1.23	1.77	10.7 ± 0.3	20.0	1560	17	26	12586024
37 × 1	19 × 0.26	1.23	1.77	14.1 ± 0.4	20.0	2590	33.2	47.1	12586025
4 × 1.5	19 × 0.31	1.49	2.17	6.7 ± 0.3	13.7	640	5.2	9.3	12586026
4 G 1.5	19 × 0.31	1.49	2.17	6.7 ± 0.3	13.7	640	5.2	9.3	84091342
7 × 1.5	19 × 0.31	1.49	2.17	8.3 ± 0.3	13.7	990	9.1	15.2	12586027
13 × 1.5	19 × 0.31	1.49	2.17	11.5 ± 0.4	13.7	1790	17	27.7	12586028
19 × 1.5	19 × 0.31	1.49	2.17	12.7 ± 0.4	13.7	2170	24.9	37.3	12586029
37 × 1.5	19 × 0.31	1.49	2.17	17.4 ± 0.4	13.7	3900	48.6	70	12586030
2 × 2.5	19 × 0.40	1.94	2.75	7.3 ± 0.3	8.21	800	4.3	9.6	12586031
3 × 2.5	19 × 0.40	1.94	2.75	7.8 ± 0.3	8.21	860	6.5	12.2	12586032
3 G 2.5	19 × 0.40	1.94	2.75	7.8 ± 0.3	8.21	860	6.5	12.2	12586032
4 × 2.5	19 × 0.40	1.94	2.75	8.6 ± 0.3	8.21	1030	8.7	15.3	12586034
4 G 2.5	19 × 0.40	1.94	2.75	8.6 ± 0.3	8.21	1030	8.7	15.3	12586035

Further constructions on request.

MM: insulation and sheath material designation according to EN 50306-1

RADOX® EN 50306-4 1E 300V MM

Conductor	according to EN 50306-2	Voltage rating	300/500 V AC
Number of conductors	2 - 48		450 V DC
Cross section	0.5 - 2.5 mm ²	Temperature range	-40 to +120 °C

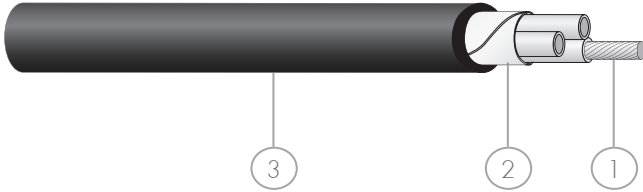

Composition of cable

1. Cores EN 50306-2	conductor Insulation colour	stranded, tin plated copper RADOX EI 306 white, numbered or green-yellow
2. Separator	tape	
3. Sheath	RADOX EM 104 colour: black	

Characteristics

- Electron beam crosslinked insulation
- Halogen free
- Flame retardant
- Best electrical performance
- Excellent resistance to high and low temperature
- Resistance to oil, ozone and weathering
- Flexible
- Easy to strip

Application

- For mechanically protection installation

Standards

Standard	Fire protection on railway vehicles	
DIN 5510-2	category	1, 2, 3, 4
EN 45545-2		
NFF 16-101	class, category	C/F0, int. A1, A2, B/ext. A1, A2, B
UNI CEI 11170-3		

For further technical details please refer to our data sheet.

Cable type	Conductor		Core	Cable	Conductor resistance	Fire load	Weight		Item no.
$n \times \text{mm}^2$	Constr. $n \times \text{mm}$	$D_{\text{nom.}}$ mm	$D_{\text{nom.}}$ mm	D mm	R_{20} max. Ω/km	nom. kJ/m	Copper kg/100 m	Cable kg/100 m	
4 × 0.5	19 × 0.18	0.88	1.42	6.1 ± 0.3	40.1	570	1.8	5.9	12586075
7 × 0.5	19 × 0.18	0.88	1.42	6.8 ± 0.3	40.1	720	3.2	8	12586076
13 × 0.5	19 × 0.18	0.88	1.42	8.9 ± 0.3	40.1	1170	5.9	13.5	12586077
19 × 0.5	19 × 0.18	0.88	1.42	9.7 ± 0.3	40.1	1410	8.7	17.4	12586078
37 × 0.5	19 × 0.18	0.88	1.42	12.8 ± 0.4	40.1	2420	16.9	31.2	12586079
2 × 0.75	19 × 0.23	1.09	1.62	5.7 ± 0.3	26.7	500	1.4	5.1	84143033
3 × 0.75	19 × 0.23	1.09	1.62	5.95 ± 0.3	26.7	540	2.1	6	85006859
4 × 0.75	19 × 0.23	1.09	1.62	6.5 ± 0.3	26.7	640	2.8	7.3	12586080
7 × 0.75	19 × 0.23	1.09	1.62	7.4 ± 0.3	26.7	840	4.9	10.5	12586081
13 × 0.75	19 × 0.23	1.09	1.62	9.8 ± 0.3	26.7	1390	9.1	18	12586082
19 × 0.75	19 × 0.23	1.09	1.62	10.7 ± 0.4	26.7	1680	13.3	23.6	12586083
37 × 0.75	19 × 0.23	1.09	1.62	14.0 ± 0.4	26.7	2810	26	42.2	12586084
48 × 0.75	19 × 0.23	1.09	1.62	15.9 ± 0.5	26.7	3500	33.7	53.5	12586085
2 × 1	19 × 0.26	1.23	1.77	6.0 ± 0.3	20.0	540	1.8	5.8	84105080
3 × 1	19 × 0.26	1.23	1.77	6.25 ± 0.3	20.0	580	2.7	6.8	85006861
4 × 1	19 × 0.26	1.23	1.77	6.9 ± 0.3	20.0	695	3.6	8.5	12586086
7 × 1	19 × 0.26	1.23	1.77	7.9 ± 0.3	20.0	915	6.3	12.4	12586087
7 G 1	19 × 0.26	1.23	1.77	7.9 ± 0.3	20.0	915	6.3	12.4	85007953
13 × 1	19 × 0.26	1.23	1.77	10.5 ± 0.4	20.0	1510	11.7	21.3	12586088
19 × 1	19 × 0.26	1.23	1.77	11.5 ± 0.4	20.0	1830	17	28.3	12586089
37 × 1	19 × 0.26	1.23	1.77	15.1 ± 0.5	20.0	3040	33.2	50.8	12586090
2 × 1.5	19 × 0.31	1.49	2.17	6.9 ± 0.3	13.7	710	2.6	7.8	85007955
3 × 1.5	19 × 0.31	1.49	2.17	7.1 ± 0.3	13.7	740	3.9	9.1	85006863
4 × 1.5	19 × 0.31	1.49	2.17	7.9 ± 0.3	13.7	910	5.2	11.5	12586091
7 × 1.5	9 × 0.31	1.49	2.17	9.0 ± 0.3	13.7	1170	9.1	16.8	12586092
7 G 1.5	9 × 0.31	1.49	2.17	9.0 ± 0.3	13.7	1170	9.1	16.8	12586099
13 × 1.5	19 × 0.31	1.49	2.17	12.3 ± 0.4	13.7	2080	17	30.1	12586093
19 × 1.5	19 × 0.31	1.49	2.17	13.5 ± 0.4	13.7	2500	24.9	39.9	12586094
37 × 1.5	19 × 0.31	1.49	2.17	18.2 ± 0.5	13.7	4380	48.6	73.9	12586095
2 × 2.5	19 × 0.40	1.94	2.75	8.0 ± 0.3	8.21	935	4.3	11.1	12586096
3 × 2.5	19 × 0.40	1.94	2.75	8.5 ± 0.3	8.21	1030	6.5	13.7	12586097
4 × 2.5	19 × 0.40	1.94	2.75	9.5 ± 0.3	8.21	1280	8.7	17.5	12586098
7 × 2.5	19 × 0.40	1.94	2.75	10.9 ± 0.4	8.21	1660	15.3	25.9	85007965
13 × 2.5	19 × 0.40	1.94	2.75	15.1 ± 0.4	8.21	2990	28.4	46.8	85007966

Further constructions on request.

MM: insulation and sheath material designation according to EN 50306-1

RADOX® EN 50306-4 3P 300V MM S

Conductor	according to EN 50306-2	Voltage rating	300/500 V AC
Number of conductors	2 - 48		450 V DC
Cross section	0.5 - 2.5 mm ²	Temperature range	-50 to +120 °C

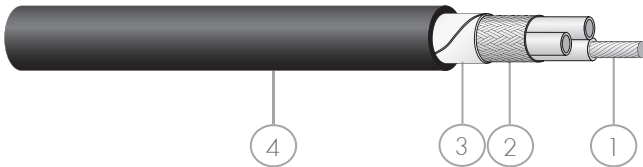

Composition of cable

1. Cores EN 50306-2	conductor insulation colour	stranded, tin plated copper RADOX EI 306 white, numbered or green-yellow
2. Screen	tin plated copper braid	
3. Separator	tape	
4. Sheath	RADOX EM 104 colour: black	

Characteristics

- Electron beam crosslinked insulation
- Halogen free
- Flame retardant
- Best electrical performance
- Excellent resistance to high and low temperature
- Resistance to oil, ozone and weathering
- Flexible
- Easy to strip

Application

- For mechanically protection installation

Standards

Standard	Fire protection on railway vehicles
DIN 5510-2	category 1, 2, 3, 4
EN 45545-2	
GOST 31565	
NFF 16-101	class, category C/F0, int. A1, A2, B/ext. A1, A2, B
NFPA 130	
UNI CEI 11170-3	

For further technical details please refer to our data sheet.

multi core, screened

Cable type	Conductor		Core	Screen	Cross section	Cable	Conductor resistance	Z_T	Fire load	Weight		Item no.
	n × mm ²	Constr. n × mm								D _{nom.} mm	D _{nom.} mm	
2 × 0.5	19 × 0.18	0.88	1.42	3.4	0.8	4.9 ± 0.3	40.1	220	335	1.7	4.1	12586036
3 × 0.5	19 × 0.18	0.88	1.42	3.6	0.8	5.0 ± 0.3	40.1	200	345	2.2	4.6	12586037
4 × 0.5	19 × 0.18	0.88	1.42	4.1	1.1	5.4 ± 0.3	40.1	150	400	2.8	5.4	12586038
6 × 0.5	19 × 0.18	0.88	1.42	5.0	1.2	6.3 ± 0.2	40.1	110	560	4	7.5	12586039
8 × 0.5	19 × 0.18	0.88	1.42	5.6	1.6	6.7 ± 0.3	40.1	90	610	5	8.8	12586040
2 × 0.75	19 × 0.23	1.09	1.62	3.8	0.8	5.1 ± 0.3	26.7	200	360	2.3	6	12586041
3 × 0.75	19 × 0.23	1.09	1.62	4.0	0.9	5.4 ± 0.3	26.7	160	400	3	5.7	12586042
4 × 0.75	19 × 0.23	1.09	1.62	4.6	1.1	5.9 ± 0.3	26.7	130	470	4	7	12586043
6 × 0.75	19 × 0.23	1.09	1.62	5.7	1.8	6.8 ± 0.3	26.7	90	640	5.6	9.6	12586044
8 × 0.75	19 × 0.23	1.09	1.62	6.1	2.1	7.4 ± 0.2	26.7	70	705	7.6	12.8	12586045
2 × 1	19 × 0.26	1.23	1.77	4.1	0.9	5.4 ± 0.3	20.0	160	395	2.7	5.5	12586046
3 × 1	19 × 0.26	1.23	1.77	4.4	1.1	5.8 ± 0.2	20.0	140	445	3.7	6.8	12586047
4 × 1	19 × 0.26	1.23	1.77	5.1	1.6	6.3 ± 0.2	20.0	110	500	5.2	8.5	12586048
6 × 1	19 × 0.26	1.23	1.77	6.0	1.8	7.3 ± 0.3	20.0	80	705	7.3	11.6	12586049
8 × 1	19 × 0.26	1.23	1.77	6.7	2.1	8.3 ± 0.3	20.0	70	870	9.3	14.8	12586050
2 × 1.5	19 × 0.31	1.49	2.17	5.0	1.4	6.4 ± 0.3	13.7	120	550	3.7	7.5	12586051
3 × 1.5	19 × 0.31	1.49	2.17	5.3	1.6	6.7 ± 0.3	13.7	100	595	5	9	12586052
4 × 1.5	19 × 0.31	1.49	2.17	6.1	1.8	7.3 ± 0.3	13.7	80	685	7	11.5	12586053
6 × 1.5	19 × 0.31	1.49	2.17	7.2	2.4	8.9 ± 0.3	13.7	60	1070	10.2	16.9	12586054
8 × 1.5	19 × 0.31	1.49	2.17	8.1	2.4	9.8 ± 0.3	13.7	100	1180	13.7	21.1	12586055
2 × 2.5	19 × 0.40	1.94	2.75	6.1	1.8	7.9 ± 0.3	8.21	80	830	6.2	11.9	12586056
3 × 2.5	19 × 0.40	1.94	2.75	6.6	2.1	8.25 ± 0.3	8.21	70	875	8.6	14.4	12586057
4 × 2.5	19 × 0.40	1.94	2.75	7.5	2.4	9.3 ± 0.3	8.21	60	1110	11	18.3	12586058

Further constructions on request.

MM: insulation and sheath material designation according to EN 50306-1

S: metallic screen braid

RADOX® EN 50306-4 3E 300V MM S

Conductor	according to EN 50306-2	Voltage rating	300/500 V AC
Number of conductors	2 - 48		450 V DC
Cross section	0.5 - 2.5 mm ²	Temperature range	-40 to +120 °C

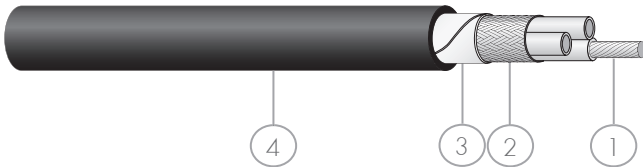

Composition of cable

1. Cores EN 50306-2	conductor insulation colour	stranded, tin plated copper RADOX EI 306 white, numbered or green-yellow
2. Screen	tin plated copper braid	
3. Separator	tape	
4. Sheath	RADOX EM 104 colour: black	

Characteristics

- Electron beam crosslinked insulation
- Halogen free
- Flame retardant
- Best electrical performance
- Excellent resistance to high and low temperature
- Resistance to oil, ozone and weathering
- Flexible
- Easy to strip

Application

- For mechanically protection installation

Standards

Standard	Fire protection on railway vehicles	
DIN 5510-2	category	1, 2, 3, 4
EN 45545-2		
NFF 16-101	class, category	C/F0, int. A1, A2, B/ext. A1, A2, B
UNI CEI 11170-3		

For further technical details please refer to our data sheet.

multi core, screened

Cable type	Conductor		Core	Screen	Cross section	Cable	Conductor resistance	Z _T	Fire load	Weight		Item no.
	n × mm ²	Constr. n × mm	D _{nom.} mm	D _{nom.} mm	D _{nom.} mm	D _{nom.} mm ²	D mm	R ₂₀ max. Ω/km	max. mΩ/m	nom. kJ/m	Copper kg/100 m	
2 × 0.5	19 × 0.18	0.88	1.42	3.4	0.8	5.9 ± 0.3	40.1	220	505	1.7	5.5	12586101
3 × 0.5	19 × 0.18	0.88	1.42	3.6	0.8	6.1 ± 0.3	40.1	200	535	2.2	6.1	12586102
4 × 0.5	19 × 0.18	0.88	1.42	4.1	1.1	6.6 ± 0.3	40.1	150	620	2.8	7.3	12586103
6 × 0.5	19 × 0.18	0.88	1.42	5.0	1.2	7.5 ± 0.3	40.1	110	800	4.3	9.9	12586104
8 × 0.5	19 × 0.18	0.88	1.42	5.6	1.6	8.2 ± 0.3	40.1	90	930	5.4	11.9	12586105
2 × 0.75	19 × 0.23	1.09	1.62	3.8	0.8	6.3 ± 0.3	26.7	200	570	2.2	6.5	12586106
3 × 0.75	19 × 0.23	1.09	1.62	4.0	0.9	6.6 ± 0.3	26.7	160	620	3	7.5	12586107
4 × 0.75	19 × 0.23	1.09	1.62	4.6	1.1	7.1 ± 0.3	26.7	130	700	4.2	9.2	12586108
6 × 0.75	19 × 0.23	1.09	1.62	5.7	1.8	8.2 ± 0.3	26.7	90	960	6	12.5	12586109
8 × 0.75	19 × 0.23	1.09	1.62	6.7	2.1	8.9 ± 0.3	26.7	70	1080	7.6	15	12586110
2 × 1	19 × 0.26	1.23	1.77	4.1	0.9	6.6 ± 0.3	20.0	160	615	2.6	7.3	12586111
3 × 1	19 × 0.26	1.23	1.77	4.4	1.1	6.9 ± 0.3	20.0	140	660	3.7	8.5	12586112
4 × 1	19 × 0.26	1.23	1.77	5.1	1.6	7.6 ± 0.3	20.0	110	780	5.2	10.7	12586113
6 × 1	19 × 0.26	1.23	1.77	6.0	1.8	8.5 ± 0.3	20.0	80	990	7.4	14.1	12586114
8 × 1	19 × 0.26	1.23	1.77	7.0	2.1	9.0 ± 0.3	20.0	70	1050	9.2	16.2	12586115
2 × 1.5	19 × 0.31	1.49	2.17	5.0	1.4	7.5 ± 0.3	13.7	120	785	3.7	9.4	12586116
3 × 1.5	19 × 0.31	1.49	2.17	5.3	1.6	7.8 ± 0.3	13.7	100	840	5	11	12586117
4 × 1.5	19 × 0.31	1.49	2.17	6.1	1.8	8.6 ± 0.3	13.7	80	995	7.1	14	12586118
6 × 1.5	19 × 0.31	1.49	2.17	7.2	2.4	9.7 ± 0.3	13.7	60	1305	10.2	18	12586119
8 × 1.5	19 × 0.31	1.49	2.17	8.7	3.8	11.1 ± 0.3	13.7	100	1730	14.2	25.2	12586120
2 × 2.5	19 × 0.40	1.94	2.75	6.1	1.8	8.7 ± 0.3	8.21	80	1040	6	13.6	12586121
3 × 2.5	19 × 0.40	1.94	2.75	6.6	2.1	9.1 ± 0.3	8.21	70	1100	8.6	16.3	12586122
4 × 2.5	19 × 0.40	1.94	2.75	7.5	2.4	10 ± 0.4	8.21	60	1330	11	20.1	12586123

Further constructions on request.

MM: insulation and sheath material designation according to EN 50306-1

S: metallic screen braid

RADOX® EN 50306-4 5P 300V MM S

Conductor	according to EN 50306-2	Voltage rating	300/500 V AC
Number of conductors	2 - 7 pairs		450 V DC
Cross section	0.5 - 1.5 mm ²	Temperature range	-40 to +120 °C

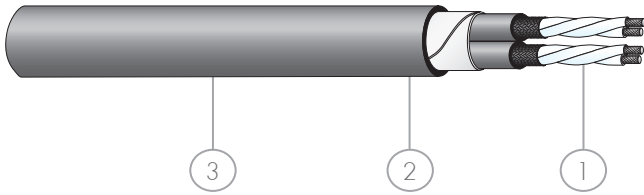

Composition of cable

1. Pair	2 × EN 50306-2 screen skin	cores twisted, white, numbered tin plated copper braid RADOX S2
2. Separator	tape	
3. Sheath	RADOX EM 104 colour: black	

Characteristics

- Electron beam crosslinked insulation
- Halogen free
- Flame retardant
- Best electrical performance
- Excellent resistance to high and low temperature
- Resistance to oil, ozone and weathering
- Flexible
- Easy to strip

Application

- For mechanically protection installation

Standards

Standard	Fire protection on railway vehicles
DIN 5510-2	category 1, 2, 3, 4
EN 45545-2	
UNI CEI 11170-3	

For further technical details please refer to our data sheet.

multipair cables, screened

Cable type	Conductor		Core		Screen	Cross section	Cable	Conductor resistance	Z _T	Fire load	Weight		Item no.
	n × mm ²	Constr. n × mm	D _{nom.} mm	D _{nom.} mm	D _{nom.} mm	nom mm ²	D mm	R ₂₀ max. Ω/km	max. mΩ/m	nom. kJ/m	Copper kg/100 m	Cable kg/100 m	
2×2×0.5	19×0.18	0.88	1.42	3.3	0.78	9.7±0.3	40.1	200	1310	3.4	11.7	12586059	
3×2×0.5	19×0.18	0.88	1.42	3.3	0.78	10.3±0.3	40.1	200	1260	5.1	12.4	12586060	
4×2×0.5	19×0.18	0.88	1.42	3.3	0.78	11.4±0.4	40.1	200	1760	6.8	17.5	12586061	
7×2×0.5	19×0.18	0.88	1.42	3.3	0.78	13.7±0.4	40.1	200	2305	12	25.8	12586062	
2×2×0.75	19×0.23	1.09	1.62	3.7	0.92	10.5±0.4	26.7	160	1525	4.65	13.2	12586063	
3×2×0.75	19×0.23	1.09	1.62	3.7	0.92	11.2±0.4	26.7	160	1710	7	16.7	12586064	
4×2×0.75	19×0.23	1.09	1.62	3.7	0.92	12.3±0.4	26.7	160	2010	9.3	20	12586065	
7×2×0.75	19×0.23	1.09	1.62	3.7	0.92	14.9±0.4	26.7	160	2410	16.4	30.4	12586066	
2×2×1	19×0.26	1.23	1.77	4.0	0.92	11.1±0.4	20.0	150	1660	5.5	14.8	12586067	
3×2×1	19×0.26	1.23	1.77	4.0	0.92	11.7±0.4	20.0	150	1780	8.2	18.2	12586068	
4×2×1	19×0.26	1.23	1.77	4.0	0.92	12.9±0.4	20.0	150	2135	11	22.1	12586069	
7×2×1	19×0.26	1.23	1.77	4.0	0.92	15.8±0.4	20.0	150	2660	19.3	34.7	12586070	
2×2×1.5	19×0.31	1.49	2.17	4.8	1.05	12.7±0.4	13.7	110	2330	7.5	20.5	12586071	
3×2×1.5	19×0.31	1.49	2.17	4.8	1.05	13.6±0.4	13.7	110	2560	11.2	25.7	12586072	
4×2×1.5	19×0.31	1.49	2.17	4.8	1.05	15.0±0.4	13.7	110	3035	15	31.2	12586073	
7×2×1.5	19×0.31	1.49	2.17	4.8	1.05	18.1±0.5	13.7	110	3660	26.1	47.6	12586074	

MM: insulation and sheath material designation according to EN 50306-1

S: metallic screen braid

RADOX® EN 50306-4 5E 300V MM S

Conductor	according to EN 50306-2	Voltage rating	300/500 V AC
Number of conductors	2 - 7 pair		450 V DC
Cross section	0.5 - 1.5 mm ²	Temperature range	-40 to +120 °C

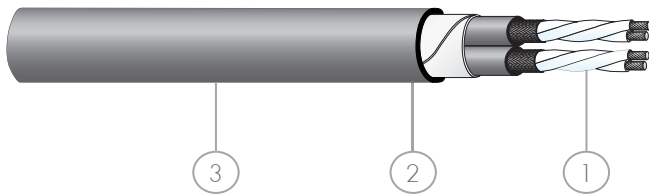

Composition of cable

1. Pair	2 × EN 50306-2 screen skin	cores twisted, white, numbered tin plated copper braid RADOX S2
2. Separator	tape	
3. Sheath	RADOX EM 104 colour: black	

Characteristics

- Electron beam crosslinked insulation
- Halogen free
- Flame retardant
- Best electrical performance
- Excellent resistance to high and low temperature
- Resistance to oil, ozone and weathering
- Flexible
- Easy to strip

Application

- For mechanically protection installation

Standards

Standard	Fire protection on railway vehicles
DIN 5510-2	category 1, 2, 3, 4
EN 45545-2	
UNI CEI 11170-3	

For further technical details please refer to our data sheet.

multipair cables, screened

Cable type	Conductor		Core		Screen	Cross section	Cable	Conductor resistance	Z _T	Fire load	Weight		Item no.
	Constr. n × mm	D _{nom.} mm	D _{nom.} mm	D _{nom.} mm							nom mm ²	D mm	
2 × 2 × 0.5	19 × 0.18	0.88	1.42	3.3	0.78	10.5 ± 0.4	40.1	200	1665	3.4	13.8	12586124	
3 × 2 × 0.5	19 × 0.18	0.88	1.42	3.3	0.78	11.2 ± 0.4	40.1	200	1815	5.1	17	12586125	
4 × 2 × 0.5	19 × 0.18	0.88	1.42	3.3	0.78	12.3 ± 0.4	40.1	200	2180	6.8	19.7	12586126	
7 × 2 × 0.5	19 × 0.18	0.88	1.42	3.3	0.78	14.3 ± 0.4	40.1	200	2705	12	29.2	12586127	
2 × 2 × 0.75	19 × 0.23	1.09	1.62	3.7	0.92	11.3 ± 0.4	26.7	160	2010	4.7	18.4	12586128	
3 × 2 × 0.75	19 × 0.23	1.09	1.62	3.7	0.92	12.0 ± 0.4	26.7	160	1995	7	19	12586129	
4 × 2 × 0.75	19 × 0.23	1.09	1.62	3.7	0.92	13.6 ± 0.4	26.7	160	2700	9.4	26.6	12586130	
7 × 2 × 0.75	19 × 0.23	1.09	1.62	3.7	0.92	15.8 ± 0.5	26.7	160	2750	16.4	33.2	12586131	
2 × 2 × 1	19 × 0.26	1.23	1.77	4.0	0.92	11.9 ± 0.4	20.0	150	1980	5.5	17.5	12586132	
3 × 2 × 1	19 × 0.26	1.23	1.77	4.0	0.92	12.7 ± 0.4	20.0	150	2090	8	21.6	12586133	
4 × 2 × 1	19 × 0.26	1.23	1.77	4.0	0.92	13.9 ± 0.4	20.0	150	2540	11	25.5	12586134	
7 × 2 × 1	19 × 0.26	1.23	1.77	4.0	0.92	16.2 ± 0.5	20.0	150	3310	18.7	39.5	12586135	
2 × 2 × 1.5	19 × 0.31	1.49	2.17	4.8	1.05	13.7 ± 0.4	13.7	110	2740	7.4	25.5	12586136	
3 × 2 × 1.5	19 × 0.31	1.49	2.17	4.8	1.05	14.4 ± 0.4	13.7	110	2780	11.1	28.8	12586137	
4 × 2 × 1.5	19 × 0.31	1.49	2.17	4.8	1.05	16.0 ± 0.5	13.7	110	3475	15	34.9	12586138	
7 × 2 × 1.5	19 × 0.31	1.49	2.17	4.8	1.05	19.2 ± 0.5	13.7	110	4115	26.2	51.7	12586139	

MM: insulation and sheath material designation according to EN 50306-1

S: metallic screen braid

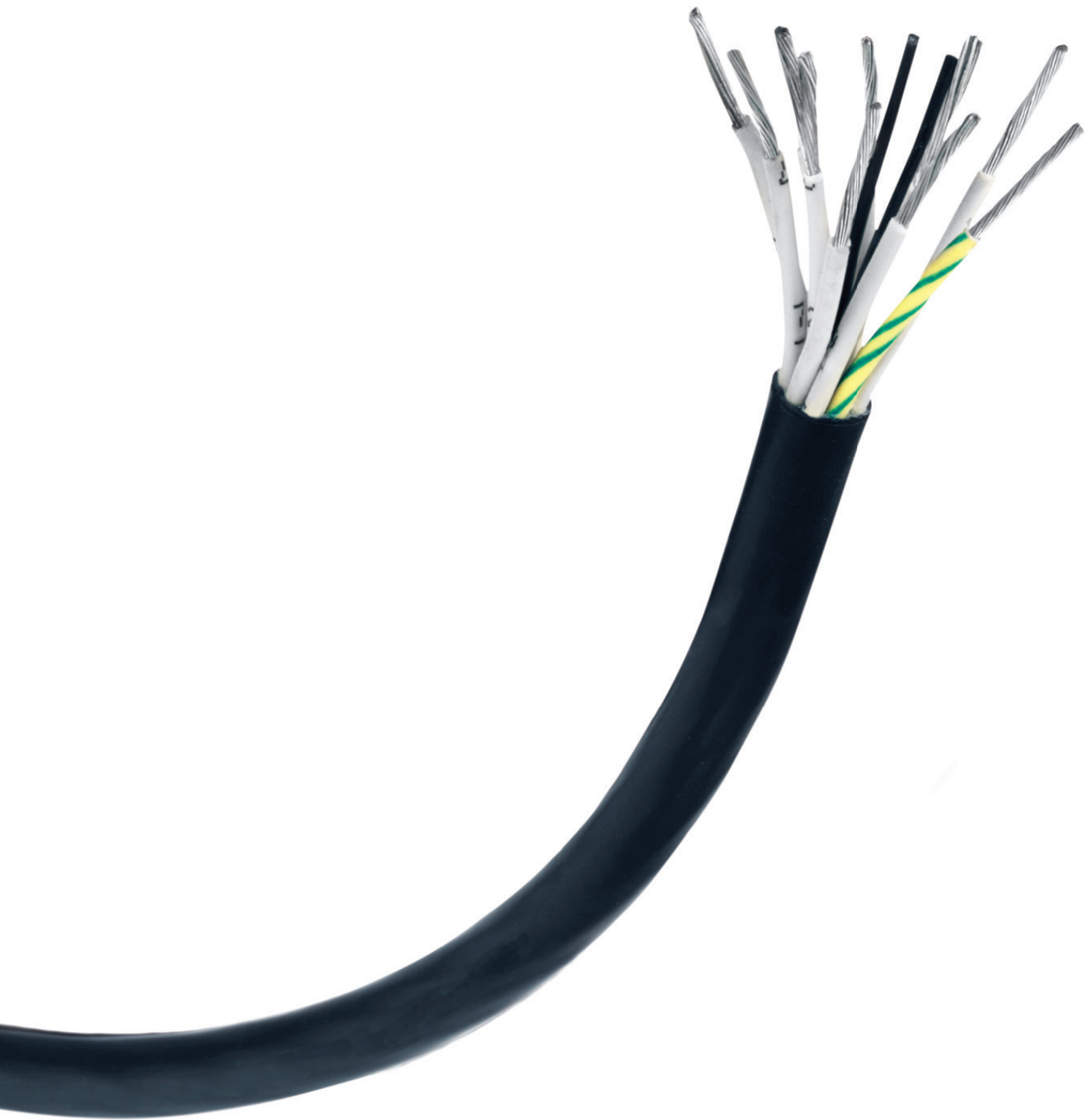

RADOX® TENNIS-TW 600V M

With the railway cable family RADOX TENNIS-TW 600V M HUBER+SUHNER offers a new generation of control and signal cable. The cable achieves a new dimension of lightness and flexibility. RADOX TENNIS-TW 600V M is smaller, lighter and more flexible than previous products on the railway market. As a thin-wall cable it is particularly suitable for the wiring of cable looms, control panels and electrical cabinets and meets the requirements of the most important European fire safety standards for railways. Unique characteristics of the cable improve its processability, making it easier to strip without the need for special tooling, therefore, greatly improving installation time and reducing costs.

RADOX TENNIS-TW 600V M cables are available in single core as well as in multi core screened and unscreened versions. The core insulation is electron-beam crosslinked and has excellent electrical and mechanical properties.

Especially developed for rolling stock, the cables are recognised for their high resistance to all types of media, UV rays, ozone and humidity as well as harsh environmental conditions. The cables are halogen free and do not release any corrosive gases in the event of fire. They are flame retardant and do not propagate fire, generate low smoke emissions and have low toxicity index.

Features

- Electron beam crosslinked
- High abrasion resistance
- Excellent flexibility
- Light weight
- Easy to strip and to install
- Meeting the common railway fire safety requirements

RADOX® TENUIS-TW 600V M

single core

Conductor	according to EN 50306-2	Voltage rating	600/1000 V AC
Number of conductors	1		900/1500 V DC
Cross section	0.34 – 4.0 mm ²	Temperature range	–50 to +120 °C

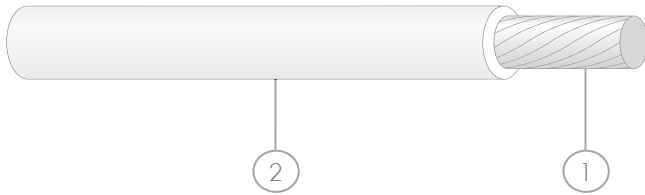

Composition of core

1. Conductor	stranded tin plated copper
2. Insulation	RADOX EI 303 colours: white, further colours on request

Characteristics and specialities

- Complies with the technical requirements of EN 50306
 - particularly low temperature
 - high level of oil and fuel resistance
- High level of thermal resistance
- Broad product range

Application

- Typical applications include carriage wiring, terminal boxes, power supply to various systems and ground connections inside railway rolling stock at fixed or sporadic moving installations.
- Guidelines for selection and the installation are described in the standards EN 50355 and EN 50343.

Standards

Standard	Fire protection on railway vehicles	
BS 6853	category	int. Ia, Ib, II/ext. Ia, Ib, II
DIN 5510-2	hazard level	1, 2, 3, 4
EN 45545-2		
GOST 31565		
NF F 16-101	class, category	C/F0, int. A1, A2, B/ext. A1, A2, B
NFPA 130		
UNI CEI 11170-3		

For further technical details please refer to our data sheet.

RADOX® TENUIS-TW 600V M

single core

Cross section	Conductor		Core	Conductor resistance	Capacity*	Fire load	Weight		Item no.
mm ²	Construction n × mm	D _{nom.} mm	D mm	R ₂₀ max. Ω/km	CH20 pF/m	nom. kJ/m	Copper kg/100 m	Cable kg/100 m	Standard colour white
0.34	19 × 0.16	0.76	1.3 ± 0.05	52.1	310	27	0.3	0.48	85027590
0.5	19 × 0.18	0.90	1.42 ± 0.03	40.1	360	33	0.5	0.6	12564379
0.75	19 × 0.23	1.10	1.62 ± 0.03	26.7	445	37	0.7	0.9	12566838
1	19 × 0.26	1.25	1.77 ± 0.03	20.0	478	43	0.9	1	12561500
1.5	19 × 0.31	1.50	2.17 ± 0.04	13.7	460	61	1.3	1.6	12564381
2.5	19 × 0.40	1.95	2.75 ± 0.05	8.21	513	95	2.2	2.6	12564382
4	56 × 0.30	2.45	3.35 ± 0.05	5.09	565	133	3.4	4	12581455

* capacity in water, typical value

M: material designation according to EN 50306-1

RADOX® TENUIS-TW 600V MM

multi core

Conductor	according to EN 50306-2	Voltage rating	600/1000 V AC
Number of conductors	2 - ...		900/1500 V DC
Cross section	0.25 - 4.0 mm ²	Temperature range	-50 to +120 °C

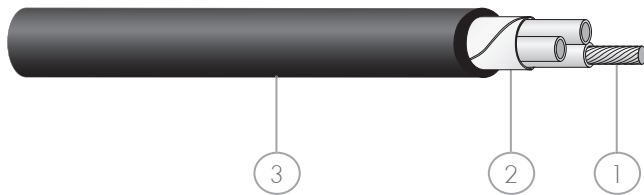

Composition of cable

1. Cores	TENUIS-TW 600V M colours: white, numbered and green-yellow further colours on request
2. Separator	tape
3. Sheath	RADOX EM 104 colour: black

Characteristics and specialities

- Complies with the technical requirements of EN 50306
 - particularly low temperature
 - high level of oil and fuel resistance
- High level of thermal resistance
- Broad product range

Application

- Typical applications include carriage wiring, terminal boxes, power supply to various systems and ground connections inside railway rolling stock at fixed or sporadic moving installations.
- Guidelines for selection and the installation are described in the standards EN 50355 and EN 50343.

Standards

Standard	Fire protection on railway vehicles	
DIN 5510-2	hazard level	1, 2, 3, 4
EN 45545-2		
GOST 31565		
NF F 16-101	class, category	C/F0, int. A1, A2, B/ext. A1, A2, B
NFPA 130		
UNI CEI 11170-3		

For further technical details please refer to our data sheet.

RADOX® TENUIS-TW 600V MM

multi core

Construction	Conductor	Core	Cable	Conductor resistance	Fire load	Weight		Item no.
mm ²	D _{nom.} mm	D _{nom.} mm	D mm	R ₂₀ max. Ω/km	nom. kJ/m	Copper kg/100 m	Cable kg/100 m	
4 × 0.25	0.61	1.17	4.5 ± 0.3	88.5	322	0.9	4.3	85064923
2 × 0.5	0.90	1.42	4.4 ± 0.2	40.1	290	0.9	3.1	12568036
3 × 0.5	0.90	1.42	4.6 ± 0.2	40.1	320	1.35	3.6	12568037
4 × 0.5	0.90	1.42	5.0 ± 0.2	40.1	362	1.8	4.3	12568038
5 × 0.5	0.90	1.42	5.5 ± 0.2	40.1	427	2.25	5.3	12566304
6 × 0.5	0.90	1.42	6.0 ± 0.2	40.1	544	2.7	6.2	12568039
2 × 2 × 0.5	0.90	1.42	6.5 ± 0.3	40.1	595	1.8	5.8	12568040
4 × 2 × 0.5	0.90	1.42	8.7 ± 0.3	40.1	900	3.6	9.9	12568041
2 × 0.75	1.10	1.62	4.75 ± 0.3	26.7	300	1.4	3.5	12568047
3 × 0.75	1.10	1.62	5.15 ± 0.3	26.7	372	2.1	4.7	12568048
4 × 0.75	1.10	1.62	5.6 ± 0.3	26.7	430	2.8	5.7	12568049
6 × 0.75	1.10	1.62	6.75 ± 0.3	26.7	659	4.2	8.3	12568050
2 × 1	1.25	1.77	5.1 ± 0.3	20.0	377	1.65	4.5	12568052
3 × 1	1.25	1.77	5.4 ± 0.3	20.0	410	2.45	5.4	12568053
4 × 1	1.25	1.77	5.8 ± 0.3	20.0	460	3.3	6.4	12568054
6 × 1	1.25	1.77	7.3 ± 0.3	20.0	887	5	9.8	12568055
10 × 1	1.25	1.77	8.7 ± 0.3	20.0	950	8.5	14.3	12581348
25 × 1	1.25	1.77	12.8 ± 0.4	20.0	1890	21.2	32.4	12581349
2 × 1.5	1.50	2.17	6.0 ± 0.3	13.7	511	2.6	6.3	12568098
3 × 1.5	1.50	2.17	6.3 ± 0.3	13.7	540	3.9	7.6	12568099
3 G 1.5	1.50	2.17	6.3 ± 0.3	13.7	540	3.9	7.6	12582026
4 × 1.5	1.50	2.17	6.9 ± 0.3	13.7	631	5.1	9.4	12568100
5 × 1.5	1.50	2.17	7.8 ± 0.3	13.7	830	6.6	11.6	12581350
5 G 1.5	1.50	2.17	7.8 ± 0.3	13.7	830	6.6	11.6	12582027
6 × 1.5	1.50	2.17	8.45 ± 0.3	13.7	1020	7.9	14.1	12582028
7 G 1.5	1.50	2.17	9.1 ± 0.3	13.7	1220	9.2	16.5	12582029
8 × 1.5	1.50	2.17	10.3 ± 0.4	13.7	1590	10.5	20.1	12582030
10 × 1.5	1.50	2.17	10.6 ± 0.4	13.7	1370	13.1	21.6	12582031
18 × 1.5	1.50	2.17	13.4 ± 0.4	13.7	2360	23.7	37.4	12582032
2 × 2.5	1.95	2.75	7.3 ± 0.3	8.21	745	4.3	9.8	12568101
3 × 2.5	1.95	2.75	7.8 ± 0.3	8.21	840	6.6	12.2	12582034
3 G 2.5	1.95	2.75	7.8 ± 0.3	8.21	840	6.6	12.2	12582035
4 × 2.5	1.95	2.75	8.7 ± 0.3	8.21	1000	8.6	15.2	12566306
5 G × 2.5	1.95	2.75	9.4 ± 0.3	8.21	1200	10.9	18.1	12585007
6 × 2.5	1.95	2.75	10.6 ± 0.4	8.21	1590	13.1	22.3	12581347

G: (earth) = green-yellow

MM: insulation and sheath material designation according to EN 50306-1

RADOX® TENUIS-TW 600V MM S

Conductor	according to EN 50306-2	Voltage rating	600/1000 V AC
Number of conductors	2 - ...		900/1500 V DC
Cross section	0.25 - 4.0 mm ²	Temperature range	-50 to +120 °C

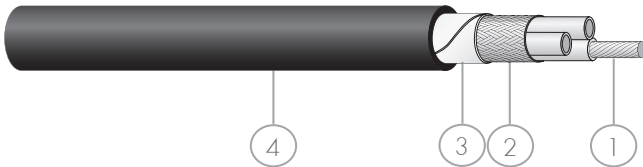

Composition of cable

1. Cores	TENUIS-TW 600V M colour: white, numbered and green-yellow further colours on request
2. EMC screen	tin plated copper braid
3. Separator	tape
4. Sheath	RADOX EM 104 colour: black

Characteristics and specialities

- Complies with the technical requirements of EN 50306
 - particularly low temperature
 - high level of oil and fuel resistance
- High level of thermal resistance
- Broad product range

Application

- Typical applications include carriage wiring, terminal boxes, power supply to various systems and ground connections inside railway rolling stock at fixed or sporadic moving installations.
- Guidelines for selection and the installation are described in the standards EN 50355 and EN 50343.

Standards

Standard	Fire protection on railway vehicles	
DIN 5510-2	hazard level	1, 2, 3, 4
EN 45545-2		
GOST 31565		
NFF 16-101	class, category	C/F0, int. A1, A2, B/ext. A1, A2, B
NFPA 130		
UNI CEI 11170-3		

For further technical details please refer to our data sheet.

multi core, screened

Construction	Conductor	Core	Cable	Conductor resistance	Fire load	Weight		Item no.
mm ²	D _{nom.} mm	D _{nom.} mm	D mm	R ₂₀ max. Ω/km	nom. kJ/m	Copper kg/100 m	Cable kg/100 m	
2 × 0.5	0.90	1.42	4.8 ± 0.3	40.1	323	1.8	4.2	12568117
6 × 0.5	0.90	1.42	6.5 ± 0.3	40.1	526	4.8	8.2	12568120
15 × 0.5	0.90	1.42	9.0 ± 0.3	40.1	1226	9.6	16.7	12582036
3 × 2 × 0.5	0.90	1.42	8.1 ± 0.3	40.1	765	4.8	9.8	12581451
12 × 2 × 0.5	0.90	1.42	13.0 ± 0.3	40.1	1594	20.6	27.6	12581358
2 × 0.75	1.10	1.62	5.0 ± 0.3	26.7	345	2.6	4.8	12568514
4 × 0.75	1.10	1.62	6.0 ± 0.3	26.7	441	4.8	7.2	12568516
6 × 0.75	1.10	1.62	7.2 ± 0.3	26.7	675	5.9	10.3	12568517
10 × 0.75	1.10	1.62	8.7 ± 0.3	26.7	896	9.6	15.2	12582046
3 × 2 × 0.75	1.10	1.62	9.0 ± 0.3	26.7	978	6.7	12.7	12581579
2 × 1	1.25	1.77	5.6 ± 0.3	20.0	430	2.7	6	12568162
4 × 1	1.25	1.77	6.5 ± 0.3	20.0	527	4.9	8.8	12568164
8 × 1	1.25	1.77	8.9 ± 0.3	20.0	1120	10.8	17.1	12581449
2 × 2 × 1	1.25	1.77	8.8 ± 0.3	20.0	877	5.5	11.7	12581357
2 × 1.5	1.50	2.17	6.5 ± 0.3	13.7	563	4.2	8.6	12568172
3 × 1.5	1.50	2.17	6.8 ± 0.3	13.7	580	5.5	9.5	12568173
4 × 1.5	1.50	2.17	7.4 ± 0.3	13.7	665	6.9	11.8	12568174
6 × 1.5	1.50	2.17	9.0 ± 0.3	13.7	1020	12	16.8	12581465
18 × 1.5	1.50	2.17	14.4 ± 0.4	13.7	3490	30.5	45.2	12582056
2 × 2.5	1.95	2.75	7.8 ± 0.3	8.21	806	6.3	12.2	12568175
3 × 2.5	1.95	2.75	8.2 ± 0.3	8.21	860	8.5	14.2	12582658
3 G 2.5	1.95	2.75	8.2 ± 0.3	8.21	860	8.5	14.2	12583736
4 × 2.5	1.95	2.75	9.1 ± 0.3	8.21	1050	11.4	18.1	12582058
5 × 2.5	1.95	2.75	10.3 ± 0.4	8.21	1278	14,3	22.4	12584926

G: (earth) = green-yellow

MM: insulation and sheath material designation according to EN 50306-1

S: metallic screen braid



RADOX® GKW-LW 600V M

Halogen free, compact, dual wall cable in a light weight design for demanding applications

RADOX GKW-LW 600V M single core cables have small diameters, low weight and a smooth and abrasion resistant surface. They are resistant to low and high temperatures, ozone and weathering and have excellent electrical characteristics, particularly in damp or humid conditions.

Due to their light weight construction, RADOX GKW-LW 600V M cables are perfect for compact system wiring applications in modern rolling stock where space is at a premium and weight is restricted.

Features

- High abrasion resistance
- Flexible
- "Light weight" design saves space and weight
- Excellent in damp or humid conditions
- Meeting the common railway fire safety requirements
- Dual wall insulation of high tech polymers

RADOX® GKW-LW 600V M

single core

Conductor	according to EN 50306-2	Voltage rating	600/1000 V AC
Number of conductors	1		900/1500 V DC
Cross section	0.5 - 2.5 mm ²	Temperature range	-50 to +120 °C



Composition of core

1. Conductor	stranded tin plated copper
2. Insulation	RADOX TI 301 colour: white

Characteristics and specialities

- Complies the technical requirements according to EN 50306
 - lowest temperature
 - high resistance to oil and fuel
- Resistance to heat
- Wide product portfolio

Application

- Typical applications include carriage wiring, terminal boxes, power supply to various systems and ground connections inside railway rolling stock at fixed installations.
- Guidelines for selection and the installation are described in the standards EN 50355 and EN 50343.

Standards

Standard	Fire protection on railway vehicles	
BS 6853	category	int. Ia, Ib, II/ext. Ia, Ib, II
DIN 5510-2	hazard level	1, 2, 3, 4
EN 45545-2		
GOST 31565		
NF F 16-101	class, category	C/F0, int. A1, A2, B/ext. A1, A2, B
NFPA 130		
UNI CEI 11170-3		

For further technical details please refer to our data sheet.

RADOX® GKW-LW 600V M

single core

Cross section		Conductor		Core	Conductor resistance	Capacity*	Fire load	Weight		Item no.
mm ²	AWG	Construction n × mm	D _{nom.} mm	D mm	R ₂₀ max. Ω/km	CH20 pF/m	nom. kJ/m	Copper kg/100 m	Cable kg/100 m	
0.5		19 × 0.18	0.90	1.30 ± 0.05	40.1	385	25	0.5	0.6	12556113
0.75		19 × 0.23	1.10	1.52 ± 0.05	26.7	470	30	0.7	0.8	12556115
1	18	19 × 0.26	1.25	1.67 ± 0.05	20.0	495	35	0.9	1	12556335
1.5		37 × 0.23	1.50	2.04 ± 0.05	13.7	475	53	1.3	1.5	12554494
2.5		19 × 0.40	1.95	2.54 ± 0.10	8.21	580	71	2.2	2.4	12554495

* capacity in water typical value

M: material designation according to EN 50306-1

RADOX® GKW-LW 600V MM

multi core

Conductor	according to EN 50306-2	Voltage rating	600/1000 V AC
Number of conductors	2 - ...		900/1500 V DC
Cross section	0.25 - 2.5 mm ²	Temperature range	-50 to +120 °C

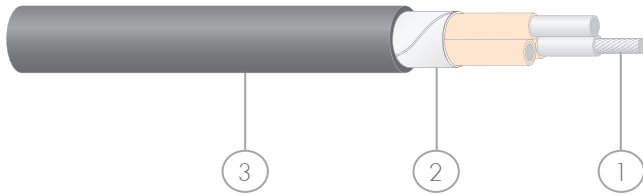

Composition of cable

1. Cores	GKW-LW 600V M colour standard: white numbered, others on request
2. Separator	tape
3. Sheath	RADOX EM 104 colour: black

Characteristics and specialities

- Complies the technical requirements according to EN 50306
 - lowest temperature
 - high resistance to oil and fuel
- Resistance to heat
- Wide product portfolio

Application

- Typical applications include carriage wiring, terminal boxes, power supply to various systems and ground connections inside railway rolling stock at fixed installations.
- Guidelines for selection and the installation are described in the standards EN 50355 and EN 50343.

Standards

Standard	Fire protection on railway vehicles	
BS 6853	category	int. Ia, Ib, II/ext. Ia, Ib, II
DIN 5510-2	hazard level	1, 2, 3, 4
EN 45545-2		
GOST 31565		
NFF 16-101	class, category	C/F0, int. A1, A2, B/ext. A1, A2, B
NFPA 130		
UNI CEI 11170-3		

For further technical details please refer to our data sheet.

Con- struction	Conductor	Core	Cable	Conductor resistance	Capacity*	Fire load	Weight		Item no.
							$n \times \text{mm}^2$	$D_{\text{nom.}}$ mm	
2 × 0.5	0.90	1.30	4.0 ± 0.2	40.1	105	245	1	2.7	12556756
4 × 0.5	0.90	1.30	4.5 ± 0.2	40.1	105	305	1.9	3.7	12556758
5 × 0.5	0.90	1.30	5.0 ± 0.2	40.1	105	375	2.3	4.6	12556759
12 × 0.5	0.90	1.30	6.9 ± 0.3	40.1	105	660	5.5	9	12556763
25 × 0.5	0.90	1.30	9.5 ± 0.3	40.1	105	1175	11.5	17.1	12561301
2 × 0.75	1.10	1.52	4.4 ± 0.2	26.7	110	290	1.4	3.4	12556767
4 × 0.75	1.10	1.52	5.0 ± 0.2	26.7	110	355	2.8	5	12556769
10 × 0.75	1.10	1.52	7.7 ± 0.3	26.7	110	750	7.1	11.3	12556773
2 × 1	1.25	1.67	4.7 ± 0.2	20.0	115	320	1.8	4.1	12556777
3 × 1	1.25	1.67	5.0 ± 0.2	20.0	115	350	2.7	5	12556778
4 × 1	1.25	1.67	5.5 ± 0.2	20.0	115	405	3.6	6.1	12556779
12 × 1	1.25	1.67	8.6 ± 0.3	20.0	115	920	11	15.8	12556783
20 × 1	1.25	1.67	11.2 ± 0.4	20.0	115	1600	18.1	26.6	12556476
2 × 1.5	1.49	2.04	5.4 ± 0.3	13.7	120	420	2.7	5.7	12556786
3 × 1.5	1.49	2.04	5.8 ± 0.3	13.7	120	465	4	7.2	12555404
3 G 1.5	1.49	2.04	5.8 ± 0.3	13.7	120	465	4	7.2	12559973
4 G 1.5	1.49	2.04	6.5 ± 0.3	13.7	120	570	5.4	9	12562759
5 G 1.5	1.49	2.04	7.2 ± 0.3	13.7	120	705	6.7	11.2	12555405
6 × 1.5	1.49	2.04	7.9 ± 0.3	13.7	120	855	8	13.5	12556788
7 G 1.5	1.49	2.04	8.4 ± 0.3	13.7	120	1000	9.4	15.6	12559975
10 × 1.5	1.49	2.04	10.0 ± 0.3	13.7	120	1180	13.5	21	12556791
18 × 1.5	1.49	2.04	12.5 ± 0.4	13.7	120	1950	24.2	36	12556793
50 × 1.5	1.49	2.04	20.1 ± 0.5	13.7	120	4565	69	94	12565315
2 × 2.5	1.95	2.55	6.6 ± 0.3	8.21	125	630	4.4	8.5	12556794
3 × 2.5	1.95	2.55	7.0 ± 0.3	8.21	125	690	6.6	10.5	12556415
4 G 2.5	1.95	2.55	7.9 ± 0.3	8.21	125	865	8.8	13.5	12562760
12 × 2.5	1.95	2.55	12.6 ± 0.4	8.21	125	1975	26.3	36	12556416

* capacity in water typical value

G: (earth) = green-yellow

MM: insulation and sheath material designation according to EN 50306-1

RADOX® GKW-LW 600V MM S

Conductor	according to EN 50306-2	Voltage rating	600/1000 V AC
Number of conductors	2 - ...		900/1500 V DC
Cross section	0.25 - 2.5 mm ²	Temperature range	-50 to +120 °C

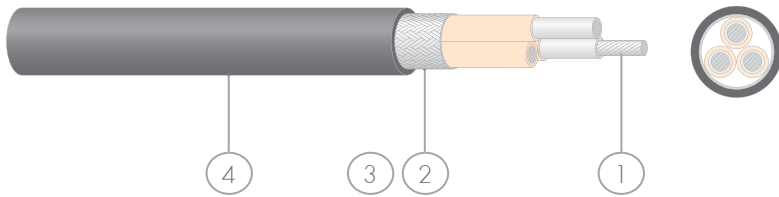

Composition of cable

1. Cores	GKW-LW 600V M colour standard: white, numbered, others on request
2. EMC screen	tin plated copper braid
3. Separator	tape
4. Sheath	RADOX EM 104 colour: black

Characteristics and specialities

- Complies the technical requirements according to EN 50306
 - lowest temperature
 - high resistance to oil and fuel
- Resistance to heat
- Wide product portfolio

Application

- Typical applications include carriage wiring, terminal boxes, power supply to various systems and ground connections inside railway rolling stock at fixed installations.
- Guidelines for selection and the installation are described in the standards EN 50355 and EN 50343.

Standards

Standard	Fire protection on railway vehicles	
BS 6853	category	int. Ia, Ib, II/ext. Ia, Ib, II
DIN 5510-2	hazard level	1, 2, 3, 4
EN 45545-2		
GOST 31565		
NFF 16-101	class, category	C/F0, int. A1, A2, B/ext. A1, A2, B
NFPA 130		
UNI CEI 11170-3		

For further technical details please refer to our data sheet.

multi core, screened

Construction	Core		Screen	Cable	Conductor resistance		Z _T	Capacity*		Fire load	Weight		Item no.
mm ²	D _{nom.} mm	D _{max.} mm	Cross section mm ²	D mm	Conductor R ₂₀ max. Ω/km	Screen R ₂₀ max. Ω/km	max. mΩ/m	Core/ screen C pF/m	Core/ screen C pF/m	kJ/m	Copper kg/100 m	Cable kg/100 m	
2 × 0.5	1.30	3.1	0.62	4.3 ± 0.3	40.1	31.1	200	110	190	255	1.6	3.3	12555592
3 × 0.5	1.30	3.3	0.75	4.5 ± 0.3	40.1	31.1	200	110	190	300	2.2	3.8	12555593
4 × 0.5	1.30	3.6	0.88	4.8 ± 0.3	40.1	31.1	150	110	190	335	2.8	4.5	12555594
6 × 0.5	1.30	4.6	1.34	5.9 ± 0.3	40.1	31.1	100	110	190	470	4.2	6.9	12555596
9 × 0.5	1.30	5.8	1.86	7.2 ± 0.3	40.1	31.1	60	110	190	640	6.0	9.7	12558109
10 × 0.5	1.30	5.8	1.88	7.2 ± 0.3	40.1	31.1	60	110	190	625	6.5	10.1	12555597
12 × 0.5	1.30	6.0	2	7.6 ± 0.3	40.1	31.1	60	110	190	735	7.5	11.6	12555598
15 × 0.5	1.30	6.8	2.80	8.5 ± 0.3	40.1	6.92	40	110	190	880	9.9	13.5	12558110
16 × 0.5	1.30	6.8	2.29	8.5 ± 0.3	40.1	6.92	40	110	190	945	9.7	14.7	12555600
25 × 0.5	1.30	8.6	3.45	10.3 ± 0.4	40.1	6.92	25	110	190	1260	15.1	21.3	12555602
2 × 2 × 0.5	1.30	5.0	1.40	6.4 ± 0.3	41.4	13.7	200	110	190	650	3.3	6.9	12555604
3 × 2 × 0.5	1.30	5.4	1.72	6.9 ± 0.3	41.4	13.7	150	110	190	580	4.5	8.2	12561834
4 × 2 × 0.5	1.30	6.4	1.72	8.0 ± 0.3	41.4	13.7	150	110	190	745	5.5	10.1	12555605
5 × 2 × 0.5	1.30	8.5	2.76	9.3 ± 0.3	41.4	13.7	60	110	190	780	7.5	13.6	12566533
6 × 2 × 0.5	1.30	7.7	3.00	9.2 ± 0.3	41.4	6.38	60	110	190	1040	8.7	14.8	12557170
10 × 2 × 0.5	1.30	9.1	3.67	10.9 ± 0.4	41.4	6.38	40	110	190	1280	13.1	20.2	12555606
2 × 0.75	1.52	3.6	0.95	4.8 ± 0.3	26.7	18.7	150	120	205	315	2.5	4.2	12556629
3 × 0.75	1.52	3.9	1.00	5.0 ± 0.3	26.7	18.7	150	120	205	320	3.0	5.0	12556636
4 × 0.75	1.52	4.3	1.15	5.5 ± 0.3	26.7	18.7	100	120	205	380	3.9	6.3	12556630
8 × 0.75	1.52	6.4	2	7.8 ± 0.3	26.7	9.8	50	120	205	815	7.6	12.3	12556631
16 × 0.75	1.52	8.1	3.45	9.7 ± 0.3	26.7	5.9	25	120	205	1110	14.6	20.4	12556419
2 × 2 × 0.75	1.52	6.2	1.72	7.8 ± 0.3	27.6	5.9	150	120	205	725	4.7	9.3	12558422
3 × 2 × 0.75	1.52	6.7	1.74	8.3 ± 0.3	27.6	11.4	150	120	205	795	6.0	10.8	12558423
2 × 1	1.67	3.8	0.88	5.0 ± 0.3	20.0	18.6	200	125	215	345	2.7	5.0	12555875
3 × 1	1.67	4.2	1.15	5.5 ± 0.3	20.0	18.6	150	125	215	390	3.9	6.2	12555688
4 × 1	1.67	4.5	1.04	5.8 ± 0.3	20.0	18.6	150	125	215	430	4.7	7.9	12555877
6 × 1	1.67	5.9	1.86	7.3 ± 0.3	20.0	10.5	100	125	215	680	7.5	11.0	12555879
2 × 2 × 1	1.67	6.9	2	8.5 ± 0.3	20.7	10.5	70	125	215	830	5.8	10.7	12558112
2 × 1.5	2.04	4.6	1.34	5.8 ± 0.3	13.7	20.7	150	125	215	455	4.3	7.4	12558888
3 × 1.5	2.04	4.9	1.14	6.2 ± 0.3	13.7	20.7	150	125	215	505	5.5	8.6	12555889
4 × 1.5	2.04	5.4	1.32	6.7 ± 0.3	13.7	20.7	100	125	215	570	7.2	10.6	12555890
12 × 1.5	2.04	9.2	3.67	11.0 ± 0.4	13.7	20.7	25	125	215	1370	20.9	28.1	12555895
2 × 2 × 1.5	2.04	8.3	3.22	10.0 ± 0.4	14.2	20.7	70	125	215	1180	9.0	16.4	12558114
2 × 2.5	2.54	5.7	1.50	7.0 ± 0.3	8.21	12.8	76	125	215	665	6.2	10.5	12557233

* capacity in water typical value

G: (earth) = green-yellow

MM: insulation and sheath material designation according to EN 50306-1

S: metallic screen braid



RADOX® 3 GKW 600V

Halogen free, compact, single wall signal and power cable for general applications

RADOX 3 GKW 600V are compact single core power and signal cables. Thanks to the medium-wall design weight and space are minimised. They are halogen free, flame retardant, low smoke and have a low toxicity index. Demands for temperature, weathering and ozone resistance are fulfilled easily.

The cable is flexible and easy to install. The RADOX insulation makes it easy to strip and is soldering iron resistant.

RADOX 3 GKW 600V cables are qualified for protected fixed cabling and installation inside of rolling stock to connect fixed parts in AC and DC applications. Typical applications include carriage wiring, terminal boxes, power supply to various systems and ground connection.

Features

- Electron beam crosslinked RADOX insulation does not melt or flow at high temperatures
- Long service life
- Compact and weight optimised
- Tight bending radii
- Meeting the common railway fire safety requirements
- Dual wall insulation of high tech polymers

RADOX® 3 GKW 600V

single core

Conductor	EN 60228, class 5	Voltage rating	600/1000 V AC
Number of conductors	1		900/1500 V DC
Cross section	0.5 - 400 mm ²	Temperature range	-50 to +120 °C

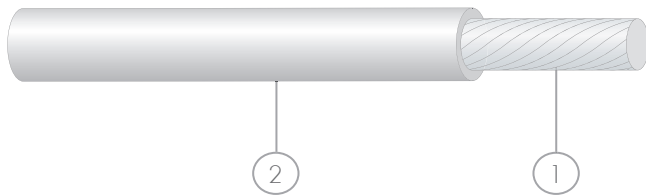

Composition of core

1. Conductor	stranded tin plated copper
2. Insulation	RADOX EI 201, colour: grey

Characteristics and specialities

- Flame retardant
- Low smoke
- Halogen free
- Low toxicity
- Soldering resistant
- Easy to strip
- Flexible
- Weight optimised

Application

- Typical applications include carriage wiring, terminal boxes, power supply to various systems and ground connections inside railway rolling stock at fixed or sporadic moving installations.
- Guidelines for selection and the installation are described in the standards EN 50355 and EN 50343.

Standards

Standard	Fire protection on railway vehicles	
BS 6853	category	int. Ia, Ib, II/ext. Ia, Ib, II
DIN 5510-2	hazard level	1, 2, 3, 4
EN 45545-2		
GOST 31565		
NFF 16-101	class, category	C/F0, int. A1, A2, B/ext. A1, A2, B
NFPA 130		
UNI CEI 11170-3		

For further technical details please refer to our data sheet.

RADOX® 3 GKW 600V

single core

Cross section	Conductor		Core	Conductor resistance	Weight		Item no.
mm ²	Construction* n × mm	D _{nom.} mm	D mm	R ₂₀ max. Ω/km	Copper kg/100 m	Cable kg/100 m	
0.5	19 × 0.18	0.90	2.00 ± 0.10	40.1	0.45	0.9	12548125
0.75	24 × 0.20	1.10	2.20 ± 0.10	26.7	0.7	1.1	12548126
1	37 × 0.18	1.22	2.45 ± 0.10	20.0	0.9	1.4	12551402
1.5	30 × 0.25	1.50	2.70 ± 0.10	13.7	1.4	1.9	12545286
2.5	50 × 0.25	1.95	3.30 ± 0.10	8.21	2.2	3.1	12545288
4	56 × 0.30	2.45	3.95 ± 0.10	5.09	3.5	4.6	12545290
6	84 × 0.30	2.95	4.70 ± 0.15	3.39	5.2	6.8	12548127
10	80 × 0.40	3.90	5.85 ± 0.15	1.95	9.1	11	12545153
16	119 × 0.40	5.30	7.25 ± 0.15	1.24	13.5	17	12545292
25	182 × 0.40	6.60	8.90 ± 0.20	0.795	21	25	12543216
35	266 × 0.40	7.80	10.2 ± 0.20	0.565	30	36	12548128
50	378 × 0.40	9.30	11.9 ± 0.20	0.393	43	50	12545155
70	348 × 0.50	11.40	14.3 ± 0.30	0.277	61	71	12543214
95	444 × 0.50	12.80	15.9 ± 0.30	0.210	78	89	12548671
120	570 × 0.50	14.90	17.9 ± 0.40	0.164	100	112	12542936
150	722 × 0.50	16.80	20.3 ± 0.40	0.132	127	142	12548673
185	874 × 0.50	18.30	22.0 ± 0.40	0.108	150	171	12551404
240	1147 × 0.50	21.10	25.2 ± 0.50	0.082	200	224	12551406
300	1443 × 0.50	23.70	28.0 ± 0.50	0.065	250	279	12555741
400	1952 × 0.50	27.30	31.9 ± 0.50	0.050	353	375	12557104

* typical value × single wire diameter

Other colours on request.

RADOX® 3 GKW 600V XM

multi core

Conductor	EN 60228, class 5	Voltage rating	600/1000 V AC
Number of conductors	2 - ...		900/1500 V DC
Cross section	0.5 - 35 mm ²	Temperature range	-50 to +120 °C

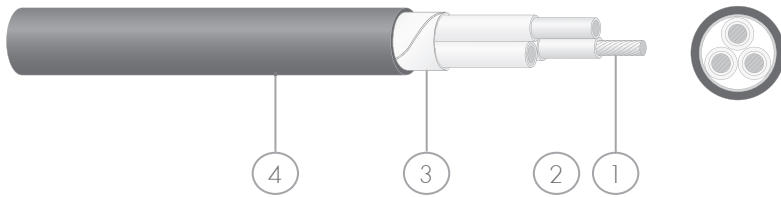

Composition of cable

1. Cores	3 GKW 600V colours: grey, numbered or with green-yellow
2. Fillers (optional)	RADOX 125 REC
3. Separator (optional)	tape
4. Sheath	RADOX EM 104 colour: black

Characteristics and specialities

- Resistance to oil, diesel oil, abrasion, ozone and weathering
- Soldering resistant
- Easy to strip
- Flexible
- Weight optimised

Application

- Typical applications include carriage wiring, terminal boxes, power supply to various systems and ground connections inside railway rolling stock at fixed or sporadic moving installations.
- Guidelines for selection and the installation are described in the standards EN 50355 and EN 50343.

Standards

Standard	Fire protection on railway vehicles	
DIN 5510-2	hazard level	1, 2, 3, 4
EN 45545-2		
GOST 31565		
NFF 16-101	class, category	C/F0, int. A1, A2, B/ext. A1, A2, B
UNI CEI 11170-3		

For further technical details please refer to our data sheet.

Construction	Conductor	Core	Cable	Conductor resistance	Capacity*	Fire load	Weight		Item no.
n × mm ²	D _{nom.} mm	D _{nom.} mm	D mm	R ₂₀ max. Ω/km	CH20 pF/m	nom. kJ/m	Copper kg/100 m	Cable kg/100 m	
2 × 0.75	1.10	2.20	6.4 ± 0.3	26.7	110	633	1.4	6	12561181
3 × 0.75	1.10	2.20	6.8 ± 0.3	26.7	110	690	2	7	12561182
4 × 0.75	1.10	2.20	7.6 ± 0.3	26.7	110	820	2.7	8.8	12561183
5 G 0.75	1.10	2.20	8.4 ± 0.3	26.7	110	990	3.4	11	12581529
7 G 0.75	1.10	2.20	10.0 ± 0.3	26.7	110	1453	4.8	15	12568622
2 × 1	1.22	2.45	6.9 ± 0.3	20.0	120	560	1.8	7.2	12561190
4 × 1	1.22	2.45	8.4 ± 0.3	20.0	120	989	3.6	11	12561192
6 × 1	1.22	2.45	10.0 ± 0.3	20.0	120	1240	5.4	16	12561194
9 × 1	1.22	2.45	12.5 ± 0.4	20.0	120	1830	8.1	22	12561196
2 × 1.5	1.50	2.70	7.5 ± 0.3	13.7	120	840	2.8	8.6	12561199
3 × 1.5	1.50	2.70	8.0 ± 0.3	13.7	120	770	4.2	11	12561200
3 G 1.5	1.50	2.70	8.0 ± 0.3	13.7	120	770	4.2	11	12563588
4 × 1.5	1.50	2.70	9.0 ± 0.3	13.7	120	1111	5.2	14	12561201
5 × 1.5	1.50	2.70	10.2 ± 0.4	13.7	120	1430	7	17	12561202
7 × 1.5	1.50	2.70	12.1 ± 0.4	13.7	120	2073	9.2	24	12561204
7 G 1.5	1.50	2.70	12.1 ± 0.4	13.7	120	1660	9.8	24	12564173
2 × 2.5	1.95	3.30	8.8 ± 0.3	8.21	130	1101	4.4	12	12561208
3 × 2.5	1.95	3.30	9.5 ± 0.3	8.21	130	1212	6.5	16	12561085
4 × 2.5	1.95	3.30	10.7 ± 0.4	8.21	130	1510	8.7	20	12561209
7 G 2.5	1.95	3.30	14.0 ± 0.4	8.21	130	2718	15	24	12567592
2 × 4	2.46	3.95	10.4 ± 0.4	5.09	150	1532	6.9	18	12561216
3 × 4	2.46	3.95	11.1 ± 0.4	5.09	150	1571	10	22	12561822
4 × 4	2.46	3.95	12.4 ± 0.4	5.09	150	2017	14	29	12561823
2 × 6	2.95	4.70	12.1 ± 0.4	3.39	150	2058	10	26	12567458
3 × 6	2.95	4.70	12.9 ± 0.4	3.39	150	2238	16	32	12561824
4 × 6	2.95	4.70	14.6 ± 0.4	3.39	150	2660	21	42	12561080
7 × 6	2.95	4.70	20.3 ± 0.5	3.39	150	5450	36	77	12581318
3 × 10	3.90	5.85	16.0 ± 0.5	1.95	150	3312	27	51	12561825
4 G 10	3.90	5.85	17.9 ± 0.5	1.95	150	3935	36	66	12567616
4 × 10	3.90	5.85	17.9 ± 0.5	1.95	150	3935	36	66	12561561
3 × 16	5.30	7.25	19.5 ± 0.5	1.24	150	4792	41	75	12566137
4 × 16	5.30	7.25	22.1 ± 0.5	1.24	150	6226	54	101	12561826
3 × 25	6.60	8.90	23.8 ± 0.5	0.795	150	6254	62	112	12565118
2 × 35	7.80	10.20	24.7 ± 0.5	0.565	150	8055	61	115	84104053
4 G 35	7.80	10.20	30.3 ± 0.5	0.565	150	10530	121	192	12567457

* capacity in water, typical value

- G: (earth) = green-yellow
- X: material not according to EN 50264-1
- M: material designation according to EN 50264-1

Additional constructions on request.

RADOX® 3 GKW 600V XM S

Conductor	EN 60228, class 5	Voltage rating	600/1000 V AC
Number of conductors	2 - 42		900/1500V DC
Cross section	0.5 - 50 mm ²	Temperature range	-50 to +120 °C

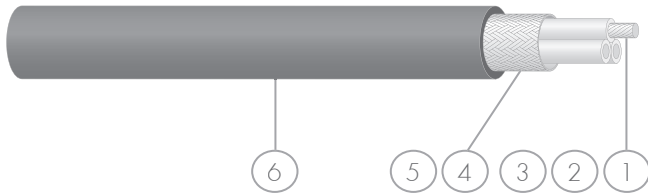

Composition of cable

1. Cores	3 GKW 600V colours: grey, numbered or with green-yellow
2. Fillers (optional)	RADOX 125 REC
3. Separator(s) (optional)	tape
4. EMC screen	tin plated copper braid
5. Separator	tape
6. Sheath	RADOX EM 104 colour: black

Characteristics and specialities

- Excellent screening properties
- Resistance to oil, diesel oil, abrasion, ozone and weathering
- Soldering resistant
- Easy to strip
- Flexible

Application

- Typical applications include carriage wiring, terminal boxes, power supply to various systems and ground connections inside railway rolling stock at fixed or sporadic moving installations.
- Guidelines for selection and the installation are described in the standards EN 50355 and EN 50343.

Standards

Standard	Fire protection on railway vehicles	
BS 6853	category	int. Ia, Ib, II/ext. Ia, Ib, II
DIN 5510-2	hazard level	1, 2, 3, 4
EN 45545-2		
GOST 31565		
NFF 16-101	class, category	C/F0, int. A1, A2, B/ext. A1, A2, B
NFPA 130		
UNI CEI 11170-3		

For further technical details please refer to our data sheet.

multi core, screened

Con- struction	Con- duc- tor	Core			Cable	Conductor resistance		Z _T	Capacity*		Fire load	Weight		Item no.
		D _{nom.} mm	D _{nom.} mm	D _{max.} mm		Size mm ²	D mm		Conduc- tor R ₂₀ nom. Ω/km	Screen R ₂₀ nom. Ω/km		max. Ω/m	Core/ core C pF/m	
2 × 0.5	0.90	2.00	4.6	1.3	6.6 ± 0.3	40.1	15.7	170	170	300	510	2.3	6.8	12561219
3 × 0.5	0.90	2.00	5.0	1.4	6.9 ± 0.3	40.1	14.5	140	170	300	640	2.8	7.7	12561220
4 × 0.5	0.90	2.00	5.8	1.7	7.5 ± 0.3	40.1	11.6	120	170	300	700	3.6	9.4	12561221
7 × 0.5	0.90	2.00	7.8	2.8	9.8 ± 0.3	40.1	7.8	80	170	300	1090	6.3	14	12561224
2 × 2 × 0.5	0.90	2.00	8.1	3.2	10.6 ± 0.4	40.1	6.2	80	170	300	1220	5	15	12567598
2 × 0.75	1.10	2.20	5.1	1.4	7.0 ± 0.3	26.7	14.6	140	170	300	678	2.9	8.1	12561228
3 × 0.75	1.10	2.20	5.4	1.7	7.5 ± 0.3	26.7	11.5	130	170	300	720	3.7	9.4	12561229
4 × 0.75	1.10	2.20	6.0	1.7	8.1 ± 0.3	26.7	12.6	100	170	300	876	4.7	11	12561230
9 × 0.75	1.10	2.20	10.0	5.1	12.3 ± 0.4	26.7	3.9	70	170	300	1630	11.4	24	12561234
16 × 0.75	1.10	2.20	11.7	5.9	14.4 ± 0.4	26.7	6.2	60	170	300	2200	16.9	35	12562206
5 × 2 × 0.75	1.10	2.20	12.8	8.0	16.0 ± 0.5	26.7	2.5	55	170	300	2250	15.4	35	12566117
2 × 1	1.22	2.45	5.7	1.8	7.6 ± 0.3	20.0	11.2	140	190	330	791	3.8	9.8	12559722
3 × 1	1.22	2.45	6.0	2.2	8.1 ± 0.3	20.0	9.6	100	190	330	712	5	11	12559723
4 × 1	1.22	2.45	7.0	2.8	8.8 ± 0.3	20.0	7.2	90	190	330	860	6.4	14	12559724
7 × 1	1.22	2.45	9.4	3.7	11.8 ± 0.4	20.0	5.3	65	190	330	1430	10	23	12559727
2 × 1.5	1.52	2.70	6.0	2.0	8.2 ± 0.3	13.7	9.9	100	190	330	907	4.6	11	12559728
3 × 1.5	1.50	2.70	6.8	2.5	8.6 ± 0.3	13.7	7.7	90	190	330	770	6.4	14	12559729
4 × 1.5	1.52	2.70	7.4	2.8	9.6 ± 0.3	13.7	7.4	80	190	330	1160	8.1	17	12559730
5 × 1.5	1.50	2.70	8.6	3.2	10.9 ± 0.4	13.7	6.2	70	190	330	1240	9.9	21	12559731
2 × 2 × 1.5	1.52	2.70	10.1	5.3	12.7 ± 0.4	13.7	4.0	60	190	330	1525	11	22	12559853
2 × 2.5	1.95	3.30	7.6	2.8	9.6 ± 0.3	8.21	7.1	80	200	350	840	6.9	16	12559734
3 G 2.5	1.95	3.30	7.8	3.2	10.4 ± 0.4	8.21	7.1	80	200	350	1307	10.4	20	12566192
4 × 2.5	1.95	3.30	9.2	3.2	11.3 ± 0.4	8.21	5.4	70	200	350	1230	12.1	24	12559736
7 × 2.5	1.95	3.30	12.1	5.9	15.7 ± 0.5	8.21	2.9	50	200	350	2000	21.3	45	12559739
3 × 4	2.45	3.95	9.5	3.7	11.8 ± 0.4	5.09	5.6	60	200	350	1400	14.4	27	12559743
4 × 4	2.54	3.95	10.6	5.3	13.4 ± 0.3	5.09	3.8	60	200	350	2146	19	36	12559848
2 × 6	2.93	4.70	10.3	5.3	12.9 ± 0.4	3.39	3.8	60	230	400	2116	16	31	12560867
3 × 6	2.95	4.70	11.4	5.1	13.8 ± 0.4	3.39	3.3	50	230	400	2240	21.8	39	12559744
4 × 6	2.93	4.70	12.6	6.1	15.6 ± 0.4	3.39	3.3	60	230	400	2888	27	49	12559745
3 × 10	3.90	5.85	14.1	7.8	17.2 ± 0.5	1.95	1.9	50	230	400	4050	36.3	63	12559746
4 × 10	3.90	5.85	16.1	10.2	19.2 ± 0.5	1.95	1.9	50	230	400	5560	43.1	79	12559747
3 × 16	5.30	7.30	17.3	10.2	20.6 ± 0.5	1.24	1.9	50	230	400	4790	52	86	12559749
4 × 16	5.30	7.25	19.2	12.3	23.2 ± 0.5	1.24	1.7	30	230	400	6112	65	109	12559850
2 × 25	6.60	8.90	19.1	12.0	22.9 ± 0.5	0.795	1.7	50	230	400	4900	53.6	100	12566322
3 × 25	6.60	8.90	20.5	13.8	24.8 ± 0.5	0.795	1.7	30	230	400	7077	78	126	12560047
4 × 25	6.60	8.90	23.7	19.4	28.3 ± 0.6	0.795	1.1	30	230	400	8559	104	165	12559750
4 × 35	7.80	10.20	26.7	22.1	31.6 ± 0.6	0.565	0.9	30	230	400	9527	142	220	12559752
2 × 50	9.30	11.9	25.0	15.2	29.8 ± 0.6	0.393	1.3	50	230	400	15000	106	175	12560868

* capacity in water typical value

- X: material not according to EN 50264-1
 - M: material designation according to EN 50264-1
 - S: metallic screen braid
- Additional constructions on request.



RADOX® 4 GW-AX 1800V M

Halogen free, compact, dual wall power cable for demanding applications

RADOX 4 GW-AX 1800V are compact, flexible single core power cables, designed for minimum cable weight and diameter. These cables meet the requirements of the modern railway industry. They are halogen free, flame retardant, low smoke and have a low toxicity index. Demands for temperature, abrasion, ozone and oil resistance are also easily fulfilled.

RADOX 4 GW-AX 1800V cores are suitable for protected, permanent routing inside and outside rolling stock with both DC and AC technology, and are especially well suited to inverter applications.

Features

- Electron beam crosslinked RADOX insulation does not melt or flow at high temperatures
- Resistant to mineral oils and detergents
- High flexibility and tight bending radii
- Easy to strip
- Meeting the common railway fire safety requirements

RADOX® 4 GKW-AX 1800V M

single core

Conductor	EN 60228, class 5	Voltage rating	1800/3000 V AC
Number of conductors	1		2700/4500 V DC
Cross section	0.5 - 400 mm ²	Temperature range	-50 to +120 °C

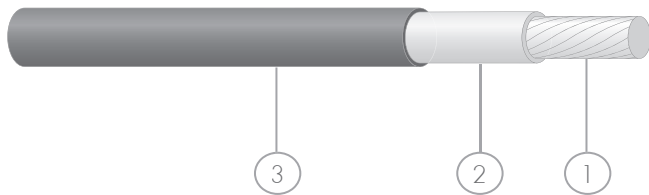

Composition of core

1. Conductor	stranded tin plated copper
2. Insulation	RADOX EI 110, colour: white
3. Sheath	RADOX EI 109, colour: black, further colours on request

Characteristics and specialties

- Complies with the most demanding of material requirements, as defined in EN 50264-3-1 1800V
 - extra low temperature
 - extra oil resistant
 - extra fuel resistance
- Resistance to ozone and weathering
- Broad product range

Application

- For protected connections of fixed and sporadic moving parts inside and outside of rolling stock.
- Guidelines for selections and the installation are described in the standards EN 50355 and EN50343.

Standards

Standard	Fire protection on railway vehicles	
BS 6853	category	int. Ia, Ib, II/ext. Ia, Ib, II
DIN 5510-2	hazard level	1, 2, 3, 4
EN 45545-2		
GOST 31565		
NF F 16-101	class, category	C/F0, int. A1, A2, B/ext. A1, A2, B
NFPA 130		
UNI CEI 11170-3		

For further technical details please refer to our data sheet.

RADOX® 4 GKW-AX 1800V M

single core

Cross section	Conductor		Core	Conductor resistance	Capacity*	Fire load	Weight		Item no.
	Construction n × mm	D mm					D mm	R ₂₀ max. Ω/km	
0.5	19 × 0.18	0.90	2.45 ± 0.10	38.5	236	91	0.5	1.1	84118052
0.75	24 × 0.20	1.10	2.65 ± 0.10	26.7	276	102	0.7	1.4	84118059
1	37 × 0.18	1.20	3.00 ± 0.10	20.0	266	132	0.9	1.8	12555986
1.5	37 × 0.23	1.50	3.55 ± 0.10	13.7	307	157	1.4	2.5	12536686
2.5	61 × 0.23	1.95	3.75 ± 0.10	8.21	362	187	2.2	3.5	12536692
4	61 × 0.29	2.40	4.50 ± 0.10	5.1	396	257	3.5	5.2	12536694
6	84 × 0.30	2.95	5.20 ± 0.15	3.4	419	334	5.2	7.4	12536696
10	80 × 0.40	3.90	6.40 ± 0.15	1.95	488	467	9.1	12	12545527
16	119 × 0.40	5.30	8.40 ± 0.20	1.24	535	801	13	19	12545528
25	182 × 0.40	6.60	10.2 ± 0.30	0.8	565	1125	21	28	12545529
35	266 × 0.40	7.80	11.7 ± 0.30	0.57	607	1457	30	40	12545530
50	378 × 0.40	9.30	13.5 ± 0.30	0.39	660	1737	43	54	12545531
70	348 × 0.50	11.4	15.8 ± 0.30	0.28	755	2178	61	75	12545532
95	444 × 0.50	12.8	17.5 ± 0.30	0.21	808	2549	78	95	12545533
120	570 × 0.50	14.9	19.8 ± 0.30	0.16	862	3118	100	120	12544522
150	722 × 0.50	16.8	22.1 ± 0.30	0.13	894	3474	127	150	12545534
185	874 × 0.50	18.3	24.0 ± 0.30	0.11	903	4432	153	182	12544523
240	1147 × 0.50	21.1	27.0 ± 0.30	0.082	994	5225	201	235	12547684
300	1443 × 0.50	23.7	29.9 ± 0.40	0.065	1060	6106	251	291	12552906
400	1952 × 0.50	27.3	34.1 ± 0.50	0.005	1115	7639	342	392	12555997

* capacity in water, typical value

Other colours on request.

M: material designation according to EN 50264-1

RADOX® 4 GKW-AX 1800V MM S

Conductor	EN 60228, class 5	Voltage rating	1800/3000 V AC
Number of conductors	1		2700/4500 V DC
Cross section	1.5 - 400 mm ²	Temperature range	-50 to +120 °C

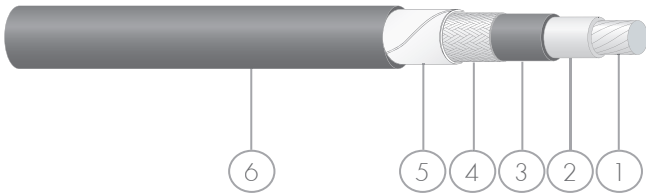

Composition of cable

1. Conductor	stranded tin plated copper
2. Insulation	RADOX EI 110, colour: white
3. Sheath	RADOX EI 109, colour: black
4. EMC screen	tin plated copper braid
5. Separator	tape
6. Sheath	RADOX EM 104, colour: black

Characteristics and specialities

- Complies with the most demanding of material requirements, as defined in EN 50264-3-1 1800V
 - extra low temperature
 - extra oil resistant
 - extra fuel resistance
- Resistance to ozone and weathering
- Good shielding action
- Broad product range

Application

- For protected connections of fixed and sporadic moving parts inside and outside of rolling stock.
- Guidelines for selections and the installation are described in the standards EN 50355 and EN50343.

Standards

Standard	Fire protection on railway vehicles	
BS 6853	category	int. Ia, Ib, II/ext. Ia, Ib, II
DIN 5510-2	hazard level	1, 2, 3, 4
EN 45545-2		
GOST 31565		
NFF 16-101	class, category	C/F0, int. A1, A2, B/ext. A1, A2, B
NFPA 130		
UNI CEI 11170-3		

For further technical details please refer to our data sheet.

single core, screened

Cross section mm ²	Core			Cable D mm	Conductor resistance		IK A	I A	Z _T mΩ/m	Capa- city* C pF/m	Fire load nom. kJ/m	Weight		Item no.
	D _{nom.} mm	D _{max.} mm	Cross sect. mm ²		Conduct. R ₂₀ max. Ω/km	Screen R ₂₀ max. Ω/km						Copper kg/ 100 m	Cable kg/ 100 m	
1.5	3.35	3.7	0.9	5.4 ± 0.15	13.7	21.33	355	18	100	254	390	2.2	5.1	12556535
2.5	3.75	4.8	1.0	6.1 ± 0.15	8.1	18.66	405	20	100	292	440	3.6	9.7	12556536
4	4.5	5.1	1.3	6.8 ± 0.15	5.1	14.14	529	24	100	322	590	4.9	9.3	12556537
6	5.2	5.7	1.5	7.7 ± 0.15	3.4	12.43	606	26	100	350	755	6.7	12	12556538
10	6.4	7.1	2.0	9.2 ± 0.2	1.95	9.48	795	30	100	392	1015	11	19	12556539
16	8.4	9.3	3.5	11.3 ± 0.2	1.24	5.70	1363	42	100	447	1550	17	28	12556540
25	10.2	11.2	4.2	13.7 ± 0.25	0.8	4.62	1637	48	100	451	2150	25	41	12556541
35	11.7	12.7	4.9	15.1 ± 0.25	0.57	3.98	1907	52	100	489	2560	35	54	12556542
50	13.5	14.7	5.6	17.0 ± 0.3	0.39	3.50	2182	57	100	512	3130	53	71	12556543
70	15.8	16.9	8.0	19.5 ± 0.3	0.28	2.67	3120	67	100	619	3680	70	97	12556544
95	17.5	18.6	9.2	21.2 ± 0.3	0.210	2.34	3564	73	100	640	4195	88	119	12556545
120	19.8	21.0	10.2	23.6 ± 0.3	0.16	2.10	3960	78	100	650	5040	114	152	12556546
150	22.1	23.6	15.7	26.2 ± 0.3	0.13	1.33	6066	103	100	719	6530	143	188	12556547
185	24.0	25.5	15.7	28.2 ± 0.3	0.11	1.37	6066	101	100	725	7290	170	220	12556548
240	27.0	28.9	20.7	31.4 ± 0.3	0.082	0.93	8023	129	100	791	8215	221	279	12556549
300	29.9	31.8	22.1	34.6 ± 0.4	0.065	0.95	8560	127	100	918	9700	276	345	12558471
400	34.1	35.9	35.7	39.5 ± 0.5	0.05	0.59	13790	176	70	1115	15320	380	480	84134935

* capacity in water, typical value

Short-circuit current rating of screen acc. to IEC 60949 (adiabatic), duration of short-circuit 0.1 s, initial temperature +90 °C, final temperature +200 °C.
Permissible continuous current of screen under standard conditions of current rating acc. to table current rating 4/9GKW-AX single core cables 557 578.

MM: insulation and sheath material designation according to EN 50264-1

S: metallic screen braid

RADOX® 4 GKW-AX 1800V MM S

Conductor	EN 60228, class 5	Voltage rating	1800/3000 V AC
Number of conductors	2 - ...		2700/4500 V DC
Cross section	1.5 - 95 mm ²	Temperature range	-50 to +120 °C

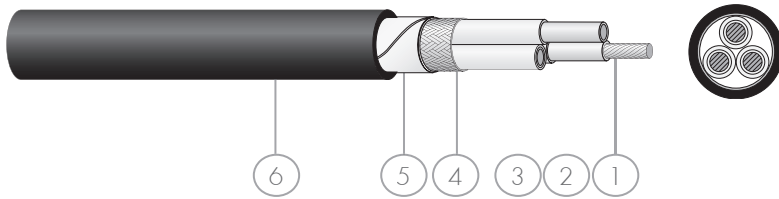

Composition of cable

1. Cores of type	4 GKW-AX 1800V M colour: black, numbered
2. Fillers (optional)	RADOX 125 REC
3. Separator(s) (optional)	tape
4. EMC screen	tin plated copper braid
5. Separator	tape
6. Sheath	RADOX EM 104, colour: black

Characteristics and specialities

- Complies with the most demanding of material requirements, as defined in EN 50264-3-1 1800V
 - extra low temperature
 - extra oil resistant
 - extra fuel resistance
- Resistance to ozone and weathering
- Good shielding action
- Broad product range

Application

- For protected connections of fixed and sporadic moving parts inside and outside of rolling stock.
- Guidelines for selections and the installation are described in the standards EN 50355 and EN50343.

Standards

Standard	Fire protection on railway vehicles	
BS 6853	category	int. Ia, Ib, II/ext. Ia, Ib, II
DIN 5510-2	hazard level	1, 2, 3, 4
EN 45545-2		
GOST 31565		
NFF 16-101	class, category	C/F0, int. A1, A2, B/ext. A1, A2, B
NFPA 130		
UNI CEI 11170-3		

For further technical details please refer to our data sheet.

multi core, screened

Construction $n \times \text{mm}^2$	Conductor $D_{\text{nom.}}$ mm	Core $D_{\text{nom.}}$ mm	Screen		Cable D mm	Conductor resistance		Z_T max. m Ω/M	Weight		Item no.
			$D_{\text{max.}}$ mm	Size mm^2		Conductor $R_{20} \text{ max.}$ Ω/km	Screen $R_{20} \text{ max.}$ Ω/km		Copper kg/100 m	Cable kg/100 m	
2 × 1.5	1.50	3.35	7.0	2.0	9.6 ± 0.3	13.7	9.2	100	4.8	14	12552642
3 × 1.5	1.50	3.35	7.6	2.8	10.5 ± 0.3	13.7	7	50	7.2	18	12566644
6 × 1.5	1.50	3.35	10.9	5.9	14.6 ± 0.4	13.7	3.3	50	15	34	12564185
2 × 2.5	1.94	3.75	8.3	3.8	10.8 ± 0.4	8.21	5.4	70	8.1	20	12583411
3 × 2.5	1.95	3.90	9.1	3.3	11.6 ± 0.4	8.21	5.9	70	10	23	12564186
4 × 2.5	1.94	3.75	10.3	5.6	13.0 ± 0.4	8.21	3.8	70	14	30	12586442
4 × 4	2.40	4.50	12.2	6.2	15.4 ± 0.5	5.1	3.5	60	21	43	12568683
3 × 6	2.93	5.20	12.2	7.1	15.4 ± 0.5	3.39	3.0	70	23	45	12584343
4 × 6	2.93	5.20	13.9	5.2	17.3 ± 0.5	3.39	3.0	70	29	56	12586443
3 × 10	3.90	6.40	15.0	8.6	18.3 ± 0.5	1.95	2.2	25	36	66	12556070
3 × 16	5.30	8.40	19.2	12.0	23.4 ± 0.5	1.24	1.6	50	54	103	12564357
4 × 16	5.30	8.40	22.1	18.0	26.6 ± 0.6	1.24	1.3	20	72	133	12584305
3 × 25	6.60	10.20	23.7	19.1	28.4 ± 0.6	0.80	1.10	50	81	153	12564358
4 × 25	6.60	10.20	27.9	18.1	33.0 ± 0.6	0.80	1.26	50	103	197	12563356
2 × 35	7.80	11.70	24.9	19.4	29.8 ± 0.6	0.57	1.06	20	80	160	12583239
3 × 35	7.80	11.70	26.7	21.5	31.7 ± 0.7	0.57	0.89	50	112	200	12561687
3 × 35 + 10	7.80 3.90	11.70 6.40	27.0	21.9	32.8 ± 0.6	0.57 1.95	1.03	50	122	214	12563359
4 × 35	7.80	11.70	30.9	35.2	37.1 ± 0.7	0.57	0.66	50	155	273	12563357
2 × 50	9.30	13.5	28.9	30.6	34.3 ± 0.6	0.39	0.7	20	116	217	12583154
3 × 50 + 10	9.30 3.90	13.5 6.40	31.0	33.2	37.0 ± 0.7	0.39 1.95	0.6	30	172	271	12563360
4 × 50	9.30	13.5	35.1	40.8	41.7 ± 0.7	0.39	0.6	30	217	360	12552458
3 × 70 + 10	11.4 3.90	15.8 6.40	35.9	38.3	41.9 ± 0.7	0.28 1.95	0.6	50	230	365	12551966
4 × 70	11.4	15.8	41.4	40.8	47.9 ± 0.7	0.28	0.6	60	289	470	12557169
3 × 95 + 10	12.8 3.90	17.5 6.40	39.6	40.8	46.7 ± 0.7	0.21 1.95	0.7	40	291	438	12559402

MM: insulation and sheath material designation according to EN 50264-1

S: metallic screen braid



RADOX® 4 GKW-AX 1800V M J

Halogen free, compact power cable for flexible applications

RADOX 4 GKW-AX 1800V M J are compact, flexible power cables, designed for minimum cable weight and diameter. They meet the high requirements of today's rail industry. The cables are also halogen free, low smoke, flame retardant and have a low toxicity index. The requirements for temperature, abrasion, ozone and oil resistance are all met without problems.

RADOX 4 GKW-AX 1800V M J non-sheathed cables are suitable for protected routing inside and outside rolling stock in which there is permanent bending stress without torsional stress in operation.

Features

- Electron beam crosslinked RADOX insulation does not melt or flow at high temperatures
- Resistant to mineral oils and detergents
- High flexible
- Easy to strip
- Meeting the common railway fire safety requirements

RADOX® 4 GKW-AX 1800V M J

single core

Conductor	EN 60228, class 5/6	Voltage rating	1800/3000 V AC
Number of conductors	1		2700/4500 V DC
Cross section	16 - 300 mm ²	Temperature range	-50 to +120 °C

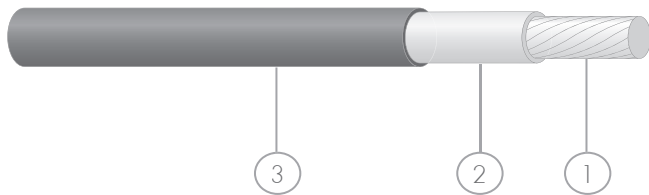

Composition of core

1. Conductor	stranded tin plated copper
2. Insulation	RADOX EI 110, colour: white
3. Sheath	RADOX EI 109, colour: black

Characteristics and specialties

- Complies with the most demanding of material requirements, as defined in EN 50264-3-1 1800V
 - extra low temperature
 - extra oil resistant
 - extra fuel resistance
- High flexibility

Application

- The cables can be used for fixed installation in rail vehicles or for mechanically protected installation under alternating bending stress.
- Guidelines for selections and the installation are described in the standards EN 50355 and EN50343.

Standards

Standard	Fire protection on railway vehicles	
BS 6853	category	int. Ia, Ib, II/ext. Ia, Ib, II
DIN 5510-2	hazard level	1, 2, 3, 4
EN 45545-2		
GOST 31565		
NF F 16-101	class, category	C/F0, int. A1, A2, B/ext. A1, A2, B
NFPA 130		
UNI CEI 11170-3		

For further technical details please refer to our data sheet.

RADOX® 4 GKW-AX 1800V M J

single core

Cross section	Conductor		Core	Conductor resistance	Capacity*	Fire load	Weight		Item no.
	Construction n × mm	D mm					D mm	R ₂₀ max. Ω/km	
16	266 × 0.30	6.0	9.1 ± 0.2	1.22	590	990	15	22	12557793
25	518 × 0.25	7.6	11.2 ± 0.3	0.795	640	1350	24	33	12558031
35	700 × 0.25	8.7	12.6 ± 0.3	0.554	670	1870	31	43	12558032
50	854 × 0.28	10.9	15.2 ± 0.3	0.385	740	2670	45	61	12558033
70	1008 × 0.30	12.2	16.7 ± 0.3	0.271	790	3150	62	82	12558034
95	1316 × 0.30	14.1	18.8 ± 0.3	0.206	860	3752	82	105	12558035
120	960 × 0.40	16.2	21.2 ± 0.3	0.164	920	4770	108	138	12558036
150	880 × 0.40 + 588 × 0.30	17.6	22.8 ± 0.3	0.132	940	5480	136	169	12558037
185	1520 × 0.40	19.7	25.5 ± 0.4	0.108	950	6270	172	211	12558038
240	1920 × 0.40	22.9	29.2 ± 0.4	0.0817	1010	8480	217	269	12558039
300	2400 × 0.40	25.1	31.4 ± 0.4	0.0654	1110	8920	271	326	12559787

* capacity in water, typical value

M: material designation according to EN 50264-1

J: high flexible conductor



RADOX® 9 GKW-AX 3600V M

Halogen free, compact, dual wall power cable

RADOX 9 GKW-AX 3600V M are compact, flexible single core power cables, designed for minimum cable weight and diameter. These cables meet the requirements of the modern railway industry. They are halogen free, flame retardant, low smoke and have a low toxicity index. Demands for temperature, abrasion, ozone and oil resistance are also fulfilled.

RADOX 9 GKW-AX 3600V M cables are applicable for installation inside and outside of rolling stock to connect fixed and moving parts in DC and AC applications, especially inverter technology applications.

Features

- Electron beam crosslinked RADOX insulation does not melt or flow at high temperatures
- Resistant to mineral oils and detergents
- High flexibility and tight bending radii
- Easy to strip
- Meeting the common railway fire safety requirements

RADOX® 9 GKW-AX 3600V M

single core

Conductor	EN 60228, class 5	Voltage rating	3600/6000 V AC
Number of conductors	1		5400/9000 V DC
Cross section	1.5 - 400 mm ²	Temperature range	-50 to +120 °C

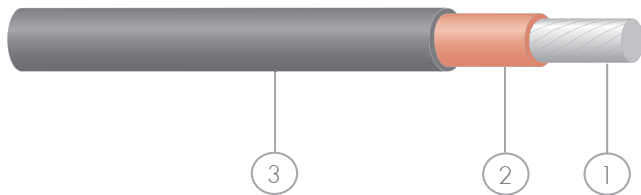

Composition of core

1. Conductor	stranded tin plated copper
2. Insulation	RADOX EI 110, colour: red
3. Sheath	RADOX EI 109, colour: black, further colours on request

Characteristics and specialties

- Fully meet the requirements according to EN 50264-3-1, hazard level 4
 - extra low temperature
 - extra oil resistant
 - extra fuel resistance
- Resistance to ozone and weathering
- Large product range

Application

- For protected connections of fixed and sporadic moving parts inside and outside of rolling stock.
- Guidelines for selections and the installation are described in the standards EN 50355 and EN50343.

Standards

Standard	Fire protection on railway vehicles	
BS 6853	category	int. Ia, Ib, II/ext. Ia, Ib, II
DIN 5510-2	hazard level	1, 2, 3, 4
EN 45545-2		
GOST 31565		
NFF 16-101	class, category	C/F0, int. A1, A2, B/ext. A1, A2, B
NFPA 130		
UNI CEI 11170-3		

For further technical details please refer to our data sheet.

RADOX® 9 GKW-AX 3600V M

single core

Cross section mm ²	Conductor		Core D mm	Conductor resistance R ₂₀ max. Ω/km	Capacity* CH20 pF/m	Fire load nom. kJ/m	Weight		Item no.
	Construction n × mm	D _{nom.} mm					Copper kg/100 m	Cable kg/100 m	
1.5	37 × 0.23	1.52	4.5 ± 0.10	13.7	215	317	1.4	3.6	12537829
2.5	61 × 0.23	1.95	5.1 ± 0.10	8.21	242	397	2.2	4.9	12537830
4	61 × 0.29	2.40	5.7 ± 0.10	5.1	280	474	3.5	6.7	12537831
6	84 × 0.30	2.95	6.3 ± 0.10	3.39	309	560	5.2	8.9	12537832
10	80 × 0.40	3.90	7.5 ± 0.15	1.95	363	742	9.1	14.1	12545520
16	119 × 0.40	5.30	9.4 ± 0.25	1.24	416	1138	13	21	12544525
25	182 × 0.40	6.60	11.0 ± 0.30	0.80	471	1444	21	30	12547257
35	266 × 0.40	7.80	12.6 ± 0.30	0.57	502	1868	30	42	12547260
50	378 × 0.40	9.30	14.6 ± 0.30	0.39	537	2355	43	58	12545521
70	348 × 0.50	11.40	16.7 ± 0.30	0.28	637	2720	61	80	12547262
95	444 × 0.50	12.90	18.7 ± 0.30	0.21	658	3404	78	101	12547264
120	570 × 0.50	14.90	21.0 ± 0.30	0.16	704	4441	100	128	12545522
150	722 × 0.50	16.80	23.2 ± 0.30	0.13	752	5208	127	160	12547268
185	874 × 0.50	18.30	25.0 ± 0.30	0.11	781	5539	153	189	12545523
240	1147 × 0.50	21.10	28.0 ± 0.30	0.082	863	6462	201	243	12547678
300	1443 × 0.50	23.70	30.8 ± 0.30	0.065	933	7379	253	301	12551573
400	1952 × 0.50	27.30	35.3 ± 0.50	0.05	955	14250	343	404	12564160

* capacity in water, typical value

M: material designation according to EN 50264-1

RADOX® 9 GKW-AX 3600V MM S

Conductor	EN 60228, class 5	Voltage rating	3600/6000 V AC
Number of conductors	1		5400/9000 V DC
Cross section	1.5 – 300 mm ²	Temperature range	–50 to +120 °C

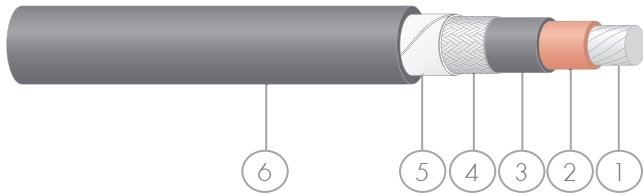

Composition of cable

1. Conductor	stranded tin plated copper
2. Insulation	RADOX EI 110, colour: red
3. Sheath	RADOX EI 109, colour: black
4. EMC screen	tin plated copper braid
5. Separator	tape
6. Sheath	RADOX EM 104 colour: black

Characteristics and specialities

- Fully meet the requirements according to EN 50264-3-1, hazard level 4
 - extra low temperature
 - extra oil resistant
 - extra fuel resistance
- Resistance to ozone and weathering
- Large product range
- High screening effectiveness

Application

- For protected connections of fixed and sporadic moving parts inside and outside of rolling stock.
- Guidelines for selections and the installation are described in the standards EN 50355 and EN50343.

Standards

Standard	Fire protection on railway vehicles	
DIN 5510-2	hazard level	1, 2, 3, 4
EN 45545-2		
GOST 31565		
NFF 16-101	class, category	C/F0, int. A1, A2, B/ext. A1, A2, B
UNI CEI 11170-3		

For further technical details please refer to our data sheet.

single core, screened

Cross section mm ²	Core		Screen		Cable		Conductor resistance		I _k	I	Z _T	Capa- city*	Fire load	Weight		Item no.
	D _{nom.} mm	D _{max.} mm	Cross section mm ²	D mm	Cond.* R ₂₀ max. Ω/km	Screen R ₂₀ max. Ω/km	Screen A	Screen A	max. mΩ/m	CH20 pF/m	nom. kJ/m	Copper kg/100 m	Cable kg/100 m			
1.5	4.5	5.0	1.1	6.60±0.15	13.7	16.9	456	21	100	171	632	2.6	7.5	12556520		
2.5	5.1	5.5	1.5	7.20±0.15	8.21	12.6	606	26	100	205	733	3.6	9.6	12556521		
4	5.7	6.4	1.9	8.20±0.15	5.1	10.2	738	29	100	223	937	5.3	12.2	12556522		
6	6.3	7.2	2.0	9.10±0.20	3.39	9.52	795	30	100	243	1083	7.4	15.6	12556523		
10	7.5	8.4	3.2	10.4±0.20	1.95	6.03	1270	40	100	293	1266	12.3	22.3	12556524		
16	9.4	10.4	5.3	12.4±0.25	1.24	4.73	2077	47	100	337	1967	19	35	12556525		
25	11	11.8	4.2	14.3±0.25	0.80	4.7	1637	47	100	373	2671	25.1	43.2	12556526		
35	12.6	13.5	4.9	15.7±0.30	0.57	4.01	1907	52	100	408	3168	35	56	12556527		
50	14.6	15.5	5.6	17.7±0.30	0.39	3.85	2182	53	100	431	3833	49	74	12556528		
70	16.7	17.7	9.2	20.0±0.30	0.28	2.21	3564	75	100	518	4610	70.6	102	12556529		
95	18.7	19.9	14.1	22.0±0.30	0.21	1.48	5460	97	100	519	5124	91	126	12556530		
120	21.0	22.2	13.7	24.7±0.30	0.16	1.46	5305	97	100	538	6646	144	160	12556531		
150	23.2	24.5	15.7	27.1±0.30	0.13	1.31	6066	104	100	596	7372	143	197	12556532		
185	25.0	26.2	15.7	29.1±0.30	0.11	1.31	6066	104	100	609	8388	170	230	12556533		
240	28	29.6	20.7	32.3±0.30	0.082	0.94	8024	128	100	673	9701	224	292	12556534		
300	30.8	32.7	22.1	35.6±0.50	0.065	1.04	8560	120	100	730	11206	291	370	12558472		

* capacity in water, typical value

Short-circuit current rating of screen acc. to IEC 60949 (adiabatic), duration of short-circuit 0.1 s, initial temperature +90 °C, final temperature +200 °C.
Permissible continuous current of screen under standard conditions of current rating acc. to table current rating 4/9 GKW single core cables 557 578.

MM: insulation and sheath material designation according to EN 50264-1

S: metallic screen braid

RADOX® 9 GKW-AX 3600V MM S

Conductor	EN 60228, class 5	Voltage rating	3600/6000 V AC
Number of conductors	2 - ...		5400/9000 V DC
Cross section	1.5 - 95 mm ²	Temperature range	-50 to +120 °C

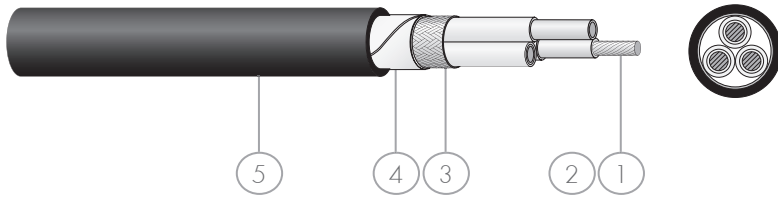

Composition of cable

1. Cores of type	9 GKW-AX 3600V M, colour: black
2. Fillers (optional)	RADOX 125 REC
3. EMC screen	tin plated copper braid
4. Separator	tape
5. Sheath	RADOX EM 104, colour: black

Characteristics and specialities

- Fully meet the requirements according to EN 50264-3-1, hazard level 4
 - extra low temperature
 - extra oil resistant
 - extra fuel resistance
- Resistance to ozone and weathering
- High screening effectiveness
- Large product range

Application

- For protected connections of fixed and sporadic moving parts inside and outside of rolling stock.
- Guidelines for selections and the installation are described in the standards EN 50355 and EN 50343.

Standards

Standard	Fire protection on railway vehicles	
DIN 5510-2	hazard level	1, 2, 3, 4
EN 45545-2		
GOST 31565		
NFF 16-101	class, category	C/F0, int. A1, A2, B/ext. A1, A2, B
UNI CEI 11170-3		

For further technical details please refer to our data sheet.

multi core, screened

Con- struction	Core		Screen	Cable	Conductor resistance		Z_T	Capacity*		Fire load	Weight		Item no.
	mm^2	D _{nom.} mm			D _{max.} mm	Cross section mm^2		D mm	Cond. R_{20} max. Ω/km		Screen R_{20} max. Ω/km	max. $\text{m}\Omega/\text{m}$	
3 × 4	5.7	13.3	7.13	16.5 ± 0.5	5.1		30	130	220	4470	17.8	44.8	85014383
6 × 4	5.7	18.7	12.5	22.8 ± 0.5	5.1		25	130	220	8585	34	84	85014384
4 × 6	6.3	17	10.6	20.8 ± 0.5	3.39	1.94	70	130	220	6976	31.5	73.2	12582210
2 × 10	7.5	16.1	9.72	19.7 ± 0.5	1.95	2.12	70	150	260	5914	28.1	65.3	12582211
4 × 35	12.6	33.4	35.7	39.7 ± 0.7	0.57	0.584	30	190	320	18860	158	294	12584431

* capacity in water, typical value

MM: insulation and sheath material designation according to EN 50264-1

S: metallic screen braid



RADOX EN 50264-3-1 600V 1x16 M

RADOX® EN 50264 family

Cores and cables for rolling stock

- With voltage rating 600/1800/3600 V AC
- With improved behaviour in case of fire
- With reduced wall isolation

RADOX high performance compounds ensure HUBER+SUHNER to fulfil the demanding requirements of the EN 50264 standards (material level: M).

Product range

EN 50264-3-1 single core		
600/1000 V AC	1.0 - 300 mm ²	
1800/3000 V AC	1.5 - 300 mm ²	
1800/3000 V AC	1.5 - 300 mm ²	with additional sheath
3600/6000 V AC	2.5 - 300 mm ²	with conductor screen and additional sheath

EN 50264-3-2 multi core		
600/1000 V AC	2 - 4 cores	unscreened
600/1000 V AC	2 - 4 cores	screened

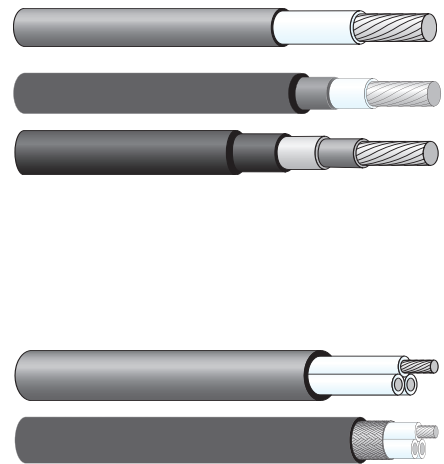

All cables have tinned copper conductor according to EN 60288, class 5, halogen free and electron beam crosslinked insulation and halogen free sheath. They are for use in railway rolling stock as fixed wiring or wiring where limited flexing in operation is encountered.

RADOX® EN 50264-3-1 600V M

single core

Conductor	EN 60228, class 5	Voltage rating	600/1000 V AC
Number of conductors	1		900 V DC
Cross section	1.0 – 300 mm ²	Temperature range	–50 to +120 °C

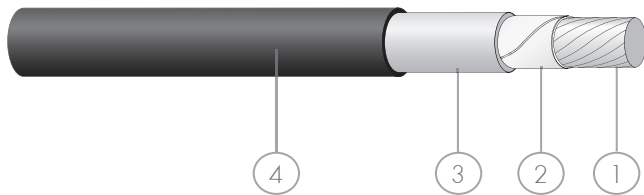

Composition of cable

1. Conductor	stranded tin plated copper	
2. Separator (≥ 25 mm ²)	tape	
3. Inner insulation	RADOX EI 110	colour: white
4. Outer insulation	RADOX EI 109	colour: black or green-yellow

Characteristics and specialities

- Dual wall insulation of high tech polymers with excellent electrical properties
- Halogen free and flame retardant
- Extra oil and fuel resistant
- Excellent resistance to high and low temperature
- Resistance to ozone and weathering
- Flexible
- Easy to strip

Application

- The cables are intended for permanent routing in rolling stock, or for locations subject to limited reciprocal bending stresses during operation.
- Specifications relating to the selection and installation of cables are described in standards EN 50355 and EN 50343.

Standards

Standard	Fire protection on railway vehicles	
DIN 5510-2	hazard level	1, 2, 3, 4
EN 45545-2		
GOST 31565		
NFF 16-101	class, category	C/F0, int. A1, A2, B/ext. A1, A2, B
UNI CEI 11170-3		

For further technical details please refer to our data sheet.

RADOX® EN 50264-3-1 600V M

single core

Core cross section mm ²	Conductor		Core D mm	Conductor resistance R ₂₀ max. Ω/km	Capacity* CH20 pF/m	Fire load nom. kJ/m	Weight		Co- lours	Item no.
	Construction n × mm	D _{nom.} mm					Copper kg/100 m	Cable kg/100 m		
1	37 × 0.18	1.22	2.50 ± 0.10	20	330	85	0.88	1.5	BK GNYE	12584832 12584833
1.5	37 × 0.23	1.52	3.00 ± 0.10	13.7	348	120	1.35	2.2	BK GNYE	12584834 12584835
2.5	61 × 0.23	1.94	3.35 ± 0.10	8.21	435	135	2.22	3.1	BK GNYE	12584836 12584837
4	61 × 0.29	2.45	4.25 ± 0.15	5.1	417	225	3.50	5	BK GNYE	12584838 12584839
6	84 × 0.30	2.93	4.85 ± 0.15	3.4	477	270	5.20	7	BK GNYE	12584840 12584841
10	80 × 0.40	3.89	5.75 ± 0.15	2	616	330	9.10	11	BK GNYE	12584842 12584843
16	119 × 0.40	5.30	7.05 ± 0.15	1.25	839	436	13.50	16	BK GNYE	12584844 12584845
25	182 × 0.40	6.60	8.60 ± 0.20	0.8	911	636	21	25	BK GNYE	12584846 12584847
35	266 × 0.40	7.80	10.1 ± 0.2	0.6	932	844	30	36	BK GNYE	12584848 12584849
50	378 × 0.40	9.30	11.6 ± 0.2	0.4	1093	940	43	49	BK GNYE	12584850 12584851
70	348 × 0.50	11.40	14.1 ± 0.25	0.3	1135	1470	61	70	BK GNYE	12584852 12584853
95	444 × 0.50	12.90	15.8 ± 0.25	0.2	1201	1570	78	89	BK GNYE	12584854 12584855
120	570 × 0.50	14.90	18.0 ± 0.3	0.16	1277	2290	100	114	BK GNYE	12584856 12584857
150	722 × 0.50	16.80	20.1 ± 0.3	0.13	1346	2760	127	140	BK GNYE	12584858 12584859
185	874 × 0.50	18.30	21.9 ± 0.3	0.11	1333	2970	153	170	BK GNYE	12584860 12584861
240	1147 × 0.50	21.10	25.0 ± 0.3	0.08	1422	3580	201	220	BK GNYE	12584862 12584863
300	1443 × 0.50	23.7	28.1 ± 0.4	0.06	1424	4480	253	280	BK GNYE	12584864 12584865

* capacity in water, typical value.

M: material designation according to EN 50264-1

RADOX® EN 50264-3-1 1800V M

single core

Conductor	IEC 60228, class 5	Voltage rating	1800/3000 V AC
Number of conductors	1		2700 V DC
Cross section	1.5 – 300 mm ²	Temperature range	–50 to +120 °C

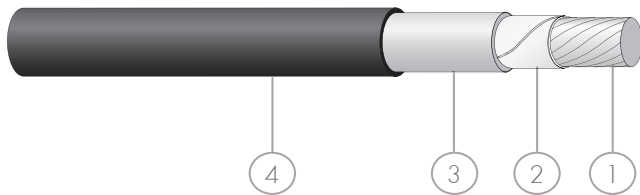

Composition of cable

1. Conductor	stranded tin plated copper	
2. Separator (≥ 25 mm ²)	tape	
3. Inner insulation	RADOX EI 110	colour: white
4. Outer insulation	RADOX EI 109	colour: black or green-yellow

Characteristics and specialities

- Dual wall insulation of high tech polymers with excellent electrical properties
- Halogen free and flame retardant
- Extra oil and fuel resistant
- Excellent resistance to high and low temperature
- Resistance to ozone and weathering
- Flexible
- Easy to strip

Application

- The cables are intended for permanent routing in rolling stock, or for locations subject to limited reciprocal bending stresses during operation.
- Specifications relating to the selection and installation of cables are described in standards EN 50355 and EN 50343.

Standards

Standard	Fire protection on railway vehicles	
DIN 5510-2	hazard level	1, 2, 3, 4
EN 45545-2		
GOST 31565		
NFF 16-101	class, category	C/F0, int. A1, A2, B/ext. A1, A2, B
NFPA 130		
UNI CEI 11170-3		

For further technical details please refer to our data sheet.

RADOX® EN 50264-3-1 1800V M

single core

Core cross section mm ²	Conductor		Core D mm	Conductor resistance R ₂₀ max. Ω/km	Capa- city* CH20 pF/m	Fire load nom. kJ/m	Weight		Colours	Item no.
	Construction n × mm	D _{nom.} mm					Copper kg/100 m	Cable kg/100 m		
1.5	37 × 0.23	1.52	5.50 ± 0.15	13.7	171	517	1.3	5.0	BK GNYE	12584866 12584867
2.5	61 × 0.23	1.94	6.05 ± 0.15	8.2	198	589	2.2	6.2	BK GNYE	12584868 12584869
4	61 × 0.29	2.40	6.65 ± 0.15	5.1	227	689	3.5	8.1	BK GNYE	12584870 12584871
6	84 × 0.30	2.93	7.15 ± 0.15	3.4	256	771	5.2	10	BK GNYE	12584872 12584873
10	80 × 0.40	3.89	8.15 ± 0.20	2	312	933	9	15	BK GNYE	12584874 12584875
16	119 × 0.40	5.30	9.60 ± 0.20	1.25	392	1220	13.5	21	BK GNYE	12584876 12584877
25	182 × 0.40	6.60	11.0 ± 0.2	0.8	458	1500	21	30	BK GNYE	12584878 12584879
35	266 × 0.40	7.80	12.2 ± 0.2	0.6	525	1700	30	40	BK GNYE	12584880 12584881
50	378 × 0.40	9.30	13.7 ± 0.2	0.4	609	1920	43	55	BK GNYE	12584882 12584883
70	348 × 0.50	11.40	16.2 ± 0.3	0.3	695	2680	61	78	BK GNYE	12584884 12584885
95	444 × 0.50	12.80	17.6 ± 0.3	0.2	768	2710	78	96	BK GNYE	12584886 12584887
120	570 × 0.50	14.90	19.7 ± 0.3	0.16	851	3490	100	120	BK GNYE	12584888 12584889
150	722 × 0.50	16.80	21.6 ± 0.3	0.13	948	3930	127	150	BK GNYE	12584890 12584891
185	874 × 0.50	18.30	23.5 ± 0.3	0.11	952	4310	153	180	BK GNYE	12584892 12584893
240	1147 × 0.50	21.10	26.4 ± 0.4	0.08	1070	4910	201	230	BK GNYE	12584894 12584895
300	1443 × 0.50	23.70	29.0 ± 0.4	0.06	1190	5450	253	290	BK GNYE	12584896 12584897

* capacity in water, typical value

M: material designation according to EN 50264-1

RADOX® EN 50264-3-1 1800V MM

Conductor	IEC 60228, class 5	Voltage rating	1800/3000 V AC
Number of conductors	1		2700 V DC
Cross section	1.5 – 300 mm ²	Temperature range	–50 to +120 °C

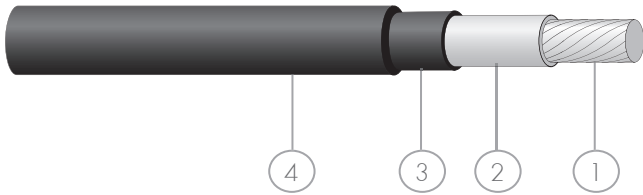

Composition of cable

1. Conductor	stranded tin plated copper	
2. Inner insulation	RADOX EI 110	colour: white
3. Outer insulation	RADOX EI 109	colour: black
4. Sheath	RADOX EM 104	colour: black

Characteristics and specialities

- Dual wall insulation of high tech polymers with excellent electrical properties
- Halogen free and flame retardant
- Extra oil and fuel resistant
- Excellent resistance to high and low temperature
- Resistance to ozone and weathering
- Flexible
- Easy to strip

Application

- The cables are intended for permanent routing in rolling stock, or for locations subject to limited reciprocal bending stresses during operation.
- Specifications relating to the selection and installation of cables are described in standards EN 50355 and EN 50343.

Standards

Standard	Fire protection on railway vehicles	
DIN 5510-2	hazard level	1, 2, 3, 4
EN 45545-2		
NFF 16-101	class, category	C/F0, int. A1, A2, B/ext. A1, A2, B
UNI CEI 11170-3		

For further technical details please refer to our data sheet.

single core, sheathed

Core cross section mm ²	Conductor		Core D mm	Cable D mm	Conductor resistance R ₂₀ max. Ω/km	Capacity* CH20 pF/m	Fire load nom. kJ/m	Weight		Item no.
	Construction n × mm	D _{nom.} mm						Copper kg/100 m	Cable kg/100 m	
1.5	37 × 0.23	1.52	4.20	5.90 + 0.15	13.7	177	265	1.3	5.40	12585360
2.5	61 × 0.23	1.94	4.70	6.40 + 0.15	8.2	204	320	2.2	6.80	12585361
4	61 × 0.29	2.40	5.20	6.90 + 0.15	5.1	238	365	3.4	8.6	12585362
6	84 × 0.30	2.93	5.70	7.40 + 0.15	3.4	267	420	5.2	11	12585363
10	80 × 0.40	3.89	7.10	8.80 + 0.20	2	302	620	9	17	12585364
16	119 × 0.40	5.30	8.60	10.4 + 0.2	1.25	371	840	13.5	23	12585365
25	182 × 0.40	6.60	10.5	12.7 + 0.25	0.8	383	1240	21	35	12585366
35	266 × 0.40	7.80	11.7	13.9 + 0.25	0.6	435	1410	30	47	12585367
50	378 × 0.40	9.30	13.2	15.4 + 0.25	0.4	501	1590	43	62	12585368
70	348 × 0.50	11.40	15.4	17.7 + 0.3	0.3	590	2100	61	85	12585369
95	444 × 0.50	12.90	17.7	20.0 + 0.3	0.2	575	2640	78	107	12585370
120	570 × 0.50	14.90	19.8	22.5 + 0.3	0.16	615	3370	100	137	12585371
150	722 × 0.50	16.80	21.7	24.4 + 0.3	0.13	680	3790	127	167	12585372
185	874 × 0.50	18.30	23.6	26.4 + 0.4	0.11	691	4170	153	199	12585373
240	1147 × 0.50	21.10	26.5	29.4 + 0.4	0.08	764	4770	201	253	12585374
300	1443 × 0.50	23.70	29.1	32.0 + 0.4	0.06	845	5290	253	311	12585375

* capacity in water, typical value

MM: insulation and sheath material designation according to EN 50264-1

RADOX® EN 50264-3-1 3600V MM

Conductor	EN 60228, class 5	Voltage rating	3600/6000 V AC
Number of conductors	1		5400 V DC
Cross section	2.5 - 300 mm ²	Temperature range	-50 to +120 °C

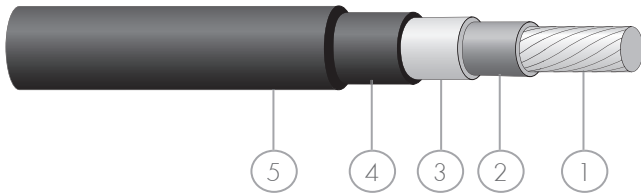

Composition of cable

1. Conductor	stranded, tin plated copper
2. Conductor screen	semi-conductor, colour: black
3. Inner layer	RADOX EI 110, colour: white
4. Outer layer	RADOX EI 109, colour: black
5. Sheath	RADOX EM 104, colour: black or green-yellow

Characteristics and specialities

- Dual wall insulation of high tech polymers with excellent electrical properties
- Halogen free and flame retardant
- Extra oil and fuel resistant
- Excellent resistance to high and low temperature
- Resistance to ozone and weathering
- Flexible
- Easy to strip

Application

- The cables are intended for permanent routing in rolling stock, or for locations subject to limited reciprocal bending stresses during operation.
- Specifications relating to the selection and installation of cables are described in standards EN 50355 and EN 50343.

Standards

Standard	Fire protection on railway vehicles	
DIN 5510-2	hazard level	1, 2, 3, 4
EN 45545-2		
GOST 31565		
UNI CEI 11170-3		

For further technical details please refer to our data sheet.

single core, sheathed

Core cross section	Conductor		Core	Cable	Conductor resistance	Capacity*	Fire load	Weight		Colours	Item no.
	Construction n × mm	D _{nom.} mm						D mm	D mm		
2.5	61 × 0.23	1.94	8.00	9.7 ± 0.2	8.2	155	2092	2.2	13	BK GNYE	12586151 12586152
4	61 × 0.30	2.40	8.60	10.4 ± 0.2	5.1	170	2378	3.5	15.7	BK GNYE	12586153 12586154
6	84 × 0.30	2.93	9.10	10.9 ± 0.2	3.4	190	2554	5.2	18.6	BK GNYE	12586155 12586156
10	80 × 0.40	3.89	10.2	12.0 ± 0.2	2	220	3011	9	24	BK GNYE	12586157 12586158
16	119 × 0.40	5.30	11.4	13.2 ± 0.2	1.25	265	3344	13.5	31	BK GNYE	12586159 12586160
25	182 × 0.40	6.60	13.3	15.6 ± 0.25	0.8	280	4566	21	45	BK GNYE	12586161 12586162
35	266 × 0.40	7.80	14.5	16.8 ± 0.3	0.6	315	5100	30	57	BK GNYE	12586163 12586164
50	378 × 0.40	9.30	16.0	18.3 ± 0.3	0.4	360	5772	43	73	BK GNYE	12586165 12586166
70	348 × 0.50	11.4	18.3	20.7 ± 0.3	0.3	415	6907	61	98	BK	12586167
95	444 × 0.50	12.9	19.7	22.1 ± 0.3	0.2	455	7500	78	117	BK	12586168
120	570 × 0.50	14.9	21.8	24.4 ± 0.3	0.16	490	8534	100	145	BK	12586169
150	722 × 0.50	16.8	23.7	26.3 ± 0.3	0.13	540	9398	127	176	BK	12586170
185	874 × 0.50	18.3	25.7	28.6 ± 0.4	0.11	550	11028	153	212	BK	12586171
240	1147 × 0.50	21.1	28.9	32.2 ± 0.4	0.08	580	13133	201	272	BK	12586172
300	1443 × 0.50	23.7	31.6	35.0 ± 0.4	0.06	630	14763	253	333	BK	12586173

* capacity in water, typical value

MM: insulation and sheath material designation according to EN 50264-1

RADOX® EN 50264-3-2 600V MM

multi core

Conductor	EN 60228, class 5	Voltage rating	600/1000 V AC
Number of conductors	2 - 4		900 V DC
Cross section	1.5 - 50 mm ²	Temperature range	-50 to +120 °C

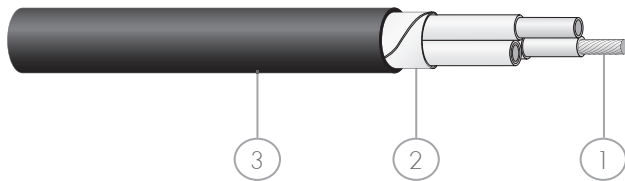

Composition of cable

1. Cores EN 50264-3-1 600V	conductor dual wall insulation colour	stranded, tin plated copper RADOX EI 110/RADOX EI 109 black, numbered
2. Separator	tape	
3. Sheath	RADOX EM 104	colour: black

Characteristics and specialities

- Dual wall insulation of high tech polymers with excellent electrical properties
- Halogen free and flame retardant
- Extra oil and fuel resistant
- Excellent resistance to high and low temperature
- Resistance to ozone and weathering
- Flexible
- Easy to strip

Application

- The cables are intended for permanent routing in rolling stock, or for locations subject to limited reciprocal bending stresses during operation.
- Specifications relating to the selection and installation of cables are described in standards EN 50355 and EN 50343.

Standards

Standard	Fire protection on railway vehicles	
DIN 5510-2	hazard level	1, 2, 3, 4
EN 45545-2		
GOST 31565		
NFF 16-101	class, category	C/F0, int. A1, A2, B/ext. A1, A2, B
UNI CEI 11170-3		

For further technical details please refer to our data sheet.

RADOX® EN 50264-3-2 600V MM

multi core

Core cross section mm ²	Conductor		Core D mm	Cable D mm	Conductor resistance R ₂₀ max. Ω/km	Capacity* CH20 pF/m	Fire load nom. kJ/m	Weight		Colours	Item no.
	Construct. n × mm	D _{nom.} mm						Copper kg/100 m	Cable kg/100 m		
2 × 1.5	37 × 0.23	1.52	3.00	7.6 ± 0.3	13.5	95	810	2.8	8.7	BK	12586174
3 × 1.5 3 G 1.5	37 × 0.23	1.52	3.00	8.1 ± 0.3	13.5	95	880	4.2	11	BK GNYE	12585380 12586176
4 × 1.5 4 G 1.5	37 × 0.23	1.52	3.00	9.0 ± 0.3	13.5	95	1070	5.7	14	BK GNYE	12586177 12586178
2 × 2.5	61 × 0.23	1.94	3.35	8.3 ± 0.3	8.2	105	930	4.4	11	BK	12586179
3 × 2.5	61 × 0.23	1.94	3.35	8.9 ± 0.3	8.2	105	1010	6.7	15.4	BK	12586180
4 × 2.5 4 G 2.5	61 × 0.23	1.94	3.35	10.1 ± 0.3	8.2	105	1290	8.9	18	BK GNYE	12586181 12586182
2 × 4	61 × 0.29	2.40	3.95	9.7 ± 0.3	5.1	110	1200	7	18	BK	12586183
3 × 4	61 × 0.29	2.40	3.95	10.5 ± 0.4	5.1	110	1410	10	22	BK GNYE	12586184 12586185
4 × 4	61 × 0.29	2.40	3.95	12.0 ± 0.4	5.1	110	1750	14	29	BK GNYE	12586186 12586187
2 × 6	84 × 0.30	2.93	4.50	11.0 ± 0.4	3.4	115	1600	10	24	BK	12586188
3 × 6	84 × 0.30	2.93	4.50	11.8 ± 0.4	3.4	115	1700	16	30	BK	12586189
4 × 6 4 G 6	84 × 0.30	2.93	4.50	13.5 ± 0.4	3.4	115	2150	21	37	BK GNYE	12586190 12586191
2 × 10	80 × 0.40	3.89	5.60	13.4 ± 0.4	2	125	2300	18	36	BK	12586192
3 × 10	80 × 0.40	3.89	5.60	14.4 ± 0.4	2	125	2260	27	46	BK GNYE	12586193 12586194
4 × 10 4 G 10	80 × 0.40	3.89	5.60	16.6 ± 0.5	2	125	3150	36	61	BK GNYE	12586195 12586196
2 × 16	119 × 0.40	5.30	7.05	16.7 ± 0.5	1.25	130	3500	27	52	BK	12586197
3 × 16	119 × 0.40	5.30	7.05	17.9 ± 0.5	1.25	130	3640	40	66	BK	12586198
4 × 16 4 G 16	119 × 0.40	5.30	7.05	20.1 ± 0.5	1.25	130	4370	54	85	BK GNYE	12586199 12586200
2 × 25	182 × 0.40	6.60	8.60	20.0 ± 0.5	0.8	135	4700	41	75	BK	12586201
3 × 25	182 × 0.40	6.60	8.60	21.6 ± 0.5	0.8	135	5280	62	99	BK	12586202
4 × 25	182 × 0.40	6.60	8.60	24.4 ± 0.5	0.8	140	6480	83	128	BK	12586203
2 × 35	266 × 0.40	7.80	10.1	23.4 ± 0.5	0.6	140	6620	60	107	BK	12586204
3 × 35	266 × 0.40	7.80	10.1	25.1 ± 0.5	0.6	140	6870	90	140	BK	12586205
3 × 35 + 1 × 25	266 × 0.40 182 × 0.40	7.80 6.60	10.1 8.60	27.7 ± 0.6	0.6 + 0.8	140	8120	110	170	BK GNYE	12586206
2 × 50	378 × 0.40	9.30	11.6	26.7 ± 0.6	0.4	145	8170	86	146	BK	12586207
3 × 50	378 × 0.40	9.30	11.6	28.8 ± 0.6	0.4	145	8420	129	190	BK	12585 381
3 × 50 + 1 × 25	378 × 0.40 182 × 0.40	9.30 6.60	11.6 8.60	32.3 ± 0.6	0.4 + 0.8	145	9480	160	200	BK GNYE	12586209

* capacity in water, typical value

MM: insulation and sheath material designation according to EN 50264-1

RADOX® EN 50264-3-2 600V MM S

Conductor	EN 60228, class 5	Voltage rating	600/1000 V AC
Number of conductors	2 - 4		900 V DC
Cross section	1.5 - 50 mm ²	Temperature range	-50 to +120 °C



Composition of cable

1. Cores EN 50264-3-1 600V	conductor dual wall insulation colour	stranded, tin plated copper RADOX EI 110/RADOX EI 109 black, numbered
2. Screen	tin plated copper braid	
3. Separator	tape	
4. Sheath	RADOX EM 104	colour: black

Characteristics and specialities

- Dual wall insulation of high tech polymers with excellent electrical properties
- Halogen free and flame retardant
- Extra oil and fuel resistant
- Excellent resistance to high and low temperature
- Resistance to ozone and weathering
- Flexible
- Easy to strip

Application

- The cables are intended for permanent routing in rolling stock, or for locations subject to limited reciprocal bending stresses during operation.
- Specifications relating to the selection and installation of cables are described in standards EN 50355 and EN 50343.

Normen

Standard	Fire protection on railway vehicles	
DIN 5510-2	hazard level	1, 2, 3, 4
EN 45545-2		
GOST 31565		
NFF 16-101	class, category	C/F0, int. A1, A2, B/ext. A1, A2, B
UNI CEI 11170-3		

For further technical details please refer to our data sheet.

multi core, screened

Core cross section	Conductor	Core	Screen		Cable	Conduct. resistance	Z _T	Capacity*		Fire load	Weight		Co-lour	Item no.
			D _{nom.} mm	D _{max.} mm				D _{nom.} mm ²	D mm		R ₂₀ max. Ω/km	max. mΩ/m		
7 G 1	1.22	2.5	8.4	3.2	10.4 ± 0.4	20	50			1319	9.5	19.4	BK	85013471
2 × 1.5	1.52	3.0	6.5	2.1	8.3 ± 0.3	13.5	80	150	255	850	4.9	11	BK	12585382
3 × 1.5 3 G 1.5	1.52	3.0	7.0	2.4	8.7 ± 0.3	13.5	70	150	255	940	6.6	14	BK GNYE	12586211 12586212
4 × 1.5 4 G 1.5	1.52	3.0	8.1	3.3	10.0 ± 0.3	13.5	60	150	255	1220	8.7	18	BK GNYE	12586213 12586214
2 × 2.5	1.94	3.35	7.3	2.4	9.0 ± 0.3	8.2	70	177	300	1010	6.9	14	BK	12586215
3 × 2.5	1.94	3.35	7.9	2.3	9.5 ± 0.3	8.2	60	177	300	1100	9.1	18	BK	12586216
4 × 2.5 4 G 2.5	1.94	3.35	9.0	3.8	11.1 ± 0.4	8.2	50	177	300	1500	13	24	BK GNYE	12586217 12586218
2 × 4	2.40	4.25	9.2	3.7	11.3 ± 0.4	5.1	50	170	290	1720	11	23	BK	12586219
3 × 4	2.40	4.25	10.1	5.5	12.4 ± 0.4	5.1	50	170	290	1845	16	29	BK	12586220
4 × 4	2.40	4.25	11.4	6.3	13.5 ± 0.4	5.1	40	170	290	2145	20	36	BK	12586221
2 × 6	2.93	4.85	10.6	5.5	12.7 ± 0.4	3.4	40	190	320	2065	16	31	BK	12586222
3 × 6	2.93	4.85	11.4	6.3	13.5 ± 0.4	3.4	40	190	320	2205	22	38	BK	12586223
4 × 6 4 G 6	2.93	4.85	12.9	7.1	15.1 ± 0.4	3.4	40	190	320	2655	28	47	BK GNYE	12586224 12586225
2 × 10	3.89	5.75	12.4	7.1	14.7 ± 0.4	2	40	230	385	2630	26	44	BK	12586226
3 × 10	3.89	5.75	13.3	7.1	15.6 ± 0.4	2	30	230	385	2810	34	54	BK	12586227
4 × 10 4 G 10	3.89	5.75	14.9	8.3	17.7 ± 0.5	2	30	230	385	3545	45	70	BK GNYE	12586228 12586229
5 G 10	3.89	5.75	17.1	10.6	20 ± 0.5	2	25	230	385	4416	57	87	BK	84117003
2 × 16	5.30	7.05	15.0	7.5	17.6 ± 0.5	1.25	30	280	480	3200	35	59	BK	12586230
3 × 16	5.30	7.05	16.4	10.6	19.2 ± 0.5	1.25	30	280	480	3900	52	80	BK	12586231
4 × 16	5.30	7.05	18.4	12.3	21.4 ± 0.5	1.25	25	280	480	4880	67	102	BK	12586232
5 G 16	5.30	7.05	20.9	13.7	24.2 ± 0.5	1.25	25	280	480	6265	82	126	BK	85002921
2 × 25	6.60	8.60	18.3	10.6	21.4 ± 0.5	0.8	25	290	495	5100	53	90	BK	12586233
3 × 25	6.60	8.60	19.7	12.4	22.7 ± 0.5	0.8	25	290	495	5400	75	115	BK	12586234
4 × 25	6.60	8.60	22.5	16.6	26.1 ± 0.5	0.8	20	290	495	7000	98	150	BK	12586235
2 × 35	7.80	10.1	21.3	13.7	24.6 ± 0.5	0.6	25	295	500	6900	75	125	BK	12586236
3 × 35	7.80	10.1	23.2	18.0	26.7 ± 0.5	0.6	20	295	500	7300	110	165	BK	12586237
3 × 35 + 1 × 25	7.80 6.60	10.1 8.60	26.0	19.4	30 ± 0.6	0.6 0.8	20	295	500	8600	130	190	BK GNYE	12586238
2 × 50	9.30	11.60	24.5	18.0	28.3 ± 0.6	0.4	20	320	545	8700	110	170	BK	12586239
3 × 50	9.30	11.60	26.4	20.8	30.8 ± 0.6	0.4	20	320	545	8800	150	215	BK	12585383
3 × 50 + 1 × 25	9.30 6.60	11.60 8.60	29.5	22.2	33.7 ± 0.6	0.4 0.8	20	320	545	9800	180	225	BK GNYE	12586241

* capacity in water, typical value; core-core
 ** capacity in water, typical value; core-screen

MM: insulation and sheath material designation according to EN 50264-1
 S: metallic screen braid

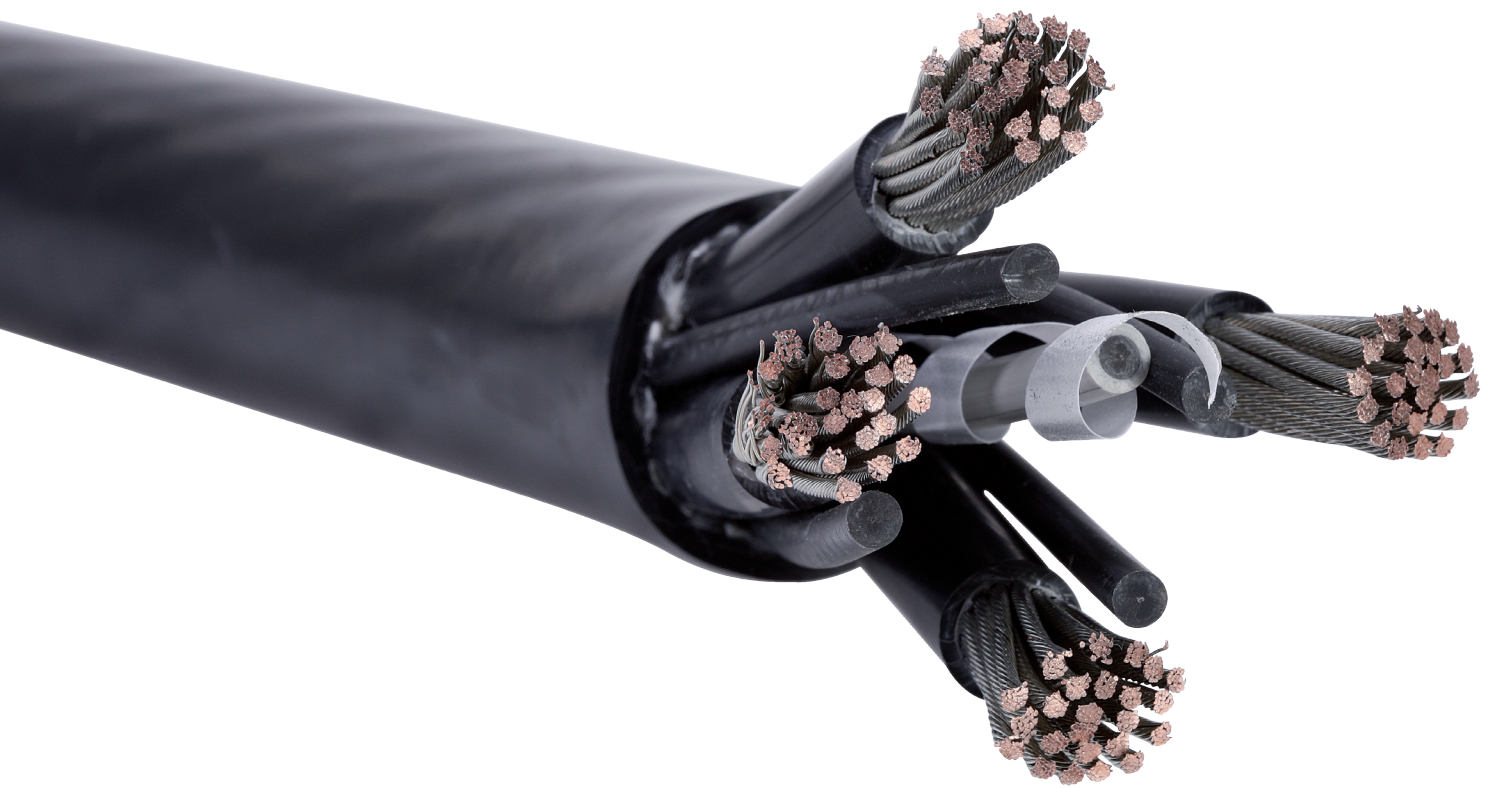

RADOX® Jumper cables

HUBER+SUHNER designs and produces a wide range of RADOX Jumper cables for data and power transmission.

RADOX Jumper cables are specially designed for demanding applications, where permanent movements combined with enhanced fire performance are required.

Our sortiment includes:

Standard single core jumper cables

Voltage V AC	Screened	Integrated torsion protection	Cable description RADOX Jumper
1800	-	-	1800V M
1800	X	X	1800V OM ST
3600	-	-	3600V MM
3600	X	-	3600V OM S
3600	X	X	3600V OM ST

Customer specific multi core cables

Composed of:

- RADOX signal and power cables
- RADOX Databus cables
- Coaxial cables
- Fiber optic cables

Features

- Very flexible
- Mechanically robust
- High abrasion resistant
- Small dimensions
- Individually configurable
- High resistance to oil, fuel, acid, alcali- and weathering
- Meeting the common railway fire safety requirements

Customer benefit

- Long operating time
- Standard solutions
- Customer specific conduit solutions

RADOX® Jumper cables

In order to ensure a long service life in demanding environments, we test our cables extensively.

Fire tests

- EN 45545-2
- DIN 5510-2
- NFF 16-101
- UNI CEI 11170-3



RADOX® Jumper cables

Environmental testing, e.g.

- Mineral oil resistance
- Acid resistance
- Alkali resistance
- Thermal ageing
- Low temperature bending and impact resistance
- Ozone resistance



Mechanical testing of jumper cables, e.g.

- Bending test >3 million cycles acc. to ICE 3 test procedure
- Bending tests at -40 °C
- Hammer impact test according to EN 60068-2-75
- Falling rocks - ballast attack
- Jacket abrasion test

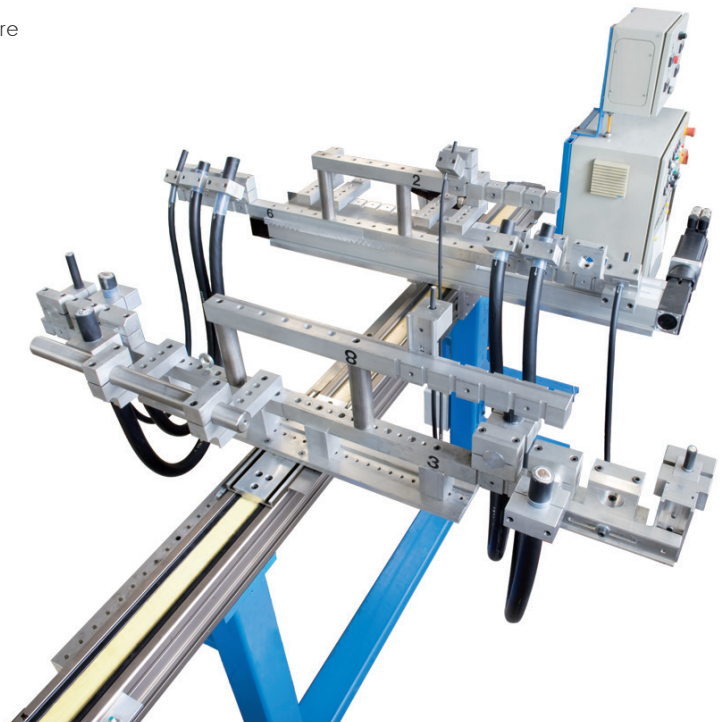

RADOX® Jumper 1800V M

single core

Conductor	EN 60228, class 5	Voltage rating	1800/3000 V AC
Number of conductors	1		2700/4500V DC
Cross section	16 - 185 mm ²	Temperature range	-40 to +110 °C



Composition of cable

1. Conductor	stranded tin plated copper, acc. EN 60228, class 5
2. Insulation	RADOX EI 110, colour: white
3. Sheath	RADOX EM 104J, colour: black

Min. bending radius*

Fixed installation	bending angle $\leq 90^\circ$	all D	$2 \times D$
	bending angle $> 90^\circ$	$D \leq 10 \text{ mm}$	$3 \times D$
	bending angle $< 90^\circ$	$D > 10 \text{ mm}$	$4 \times D$
Free installation			$7 \times D$

* Provided that careful and competent handling is used in combination with proven fixture methods.

Application

- RADOX Jumper cables are especially well suited to situations where continuous movement and stringent fire safety requirements have to be taken into account (without torsion loading).

Standards

Standard	Fire protection on railway vehicles	
DIN 5510-2	hazard level	1, 2, 3, 4
EN 45545-2		
NFPA 130		
UNI CEI 11170-3		

For further technical details please refer to our data sheet.

RADOX® Jumper 1800V M

single core

Cross section	Conductor		Cable	Conductor resistance	Capacity*	Fire load	Weight		Item no.
	Construction n × mm	D _{nom.} mm					D mm	R ₂₀ max. Ω/km	
16	266 × 0.30	6.0	11.0 ± 0.3	1.22	390	1671	16	26	12585829
25	518 × 0.25	7.6	12.5 ± 0.3	0.8	480	1938	25	36	84101651
35	700 × 0.25	8.6	13.5 ± 0.3	0.55	538	2116	32	45	84097272
50	854 × 0.30	10.9	16.0 ± 0.3	0.39	635	2686	45	64	84095698
70	1008 × 0.30	12.2	17.5 ± 0.3	0.27	683	3063	63	85	84095709
95	1316 × 0.30	14.1	19.5 ± 0.3	0.21	756	3559	82	107	84098661
120	960 × 0.40	16.2	21.5 ± 0.3	0.16	867	3923	109	139	84101650
150	880 × 0.40 + 588 × 0.30	17.6	23.0 ± 0.3	0.13	906	4341	136	169	84094779
185	1520 × 0.40	19.7	25.0 ± 0.3	0.11	1010	4721	172	207	12585830

* capacity in water, typical value

M: material designation according to EN 50264-1

RADOX® Jumper 1800V OM S T

Conductor	EN 60228, class 5	Voltage rating	1800/3000 V AC
Number of conductors	1		2700/4500 V DC
Cross section	16 - 185 mm ²	Temperature range	-40 to +110 °C

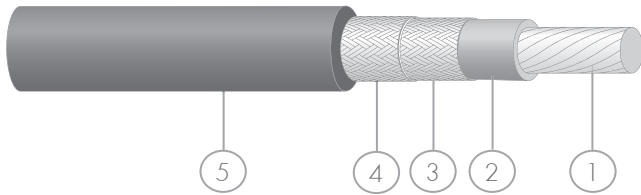

Composition of cable

1. Conductor	stranded tin plated copper, acc. EN 60228, class 5
2. Insulation	RADOX EI 110, colour: white RADOX EI 109, colour: black
3. EMC screen	tin plated copper braid
4. Torsion protection	textil yarn
5. Sheath	RADOX EM 104J, colour: black

Min. bending radius*

Fixed installation	bending angle $\leq 90^\circ$	all D	2 × D
	bending angle $> 90^\circ$	D ≤ 10 mm	3 × D
	bending angle $< 90^\circ$	D > 10 mm	4 × D
Free installation			10 × D

* Provided that careful and competent handling is used in combination with proven fixture methods.

Application

- RADOX Jumper cables are particularly well suited to situations where continuous movement with torsion loads have to be taken into account alongside stringent fire safety requirements.

Standards

Standard	Fire protection on railway vehicles	
DIN 5510-2	hazard level	1, 2, 3, 4
EN 45545-2		
UNI CEI 11170-3		

For further technical details please refer to our data sheet.

single core, screened, with torsion protection

Cross section	Conductor		Core	Screen		Cable	Conductor resistance		Z_T	Cap-acity*	Fire load	Weight		Item no.
	Construction n × mm	D _{nom.} mm		D mm	D _{max.} mm		mm ²	D mm				Cond. R ₂₀ max. Ω/km	Screen R ₂₀ max. Ω/km	
16	266 × 0.30	6.0	10.3	11.1	3.46	15.5 ± 0.30	1.22	8.5	250	448	3206	21	43	84119864
25	518 × 0.25	7.6	12.0	12.8	3.96	17.5 ± 0.30	0.8	7.5	250	530	3967	30	57	84128731
35	700 × 0.25	8.6	13.2	14.0	4.45	18.5 ± 0.30	0.55	6.7	250	579	4241	38	68	84095754
50	854 × 0.30	10.9	15.6	16.6	6.34	21.0 ± 0.30	0.39	4.7	250	694	4979	54	91	12585831
70	1008 × 0.30	12.2	17.0	18.0	7.13	22.5 ± 0.30	0.27	4.2	250	757	5585	73	114	12585837
95	1316 × 0.30	14.1	19.0	20.0	8.32	24.5 ± 0.30	0.21	3.6	250	837	6273	94	140	84101653
120	960 × 0.40	16.2	21.1	22.1	8.32	26.5 ± 0.30	0.16	3.7	250	950	6843	121	174	12585832
150	880 × 0.40 + 588 × 0.30	17.6	22.5	23.5	9.51	28.0 ± 0.40	0.13	3.1	250	1014	7370	150	207	84098250
185	1520 × 0.40	19.7	24.7	25.7	9.51	30.5 ± 0.40	0.11	3.3	250	1102	8555	186	251	84119900

* capacity conductor/screen typical value

- O: insulation material designation according to EN 50264-1
- M: material designation according to EN 50264-1
- S: metallic screen braid
- T: torsion protection

RADOX® Jumper 3600V MM single core

Conductor	EN 60228, class 5	Voltage rating	3600/6000 V AC
Number of conductors	1		5400/9000 V DC
Cross section	16 - 185 mm ²	Temperature range	-40 to +110 °C

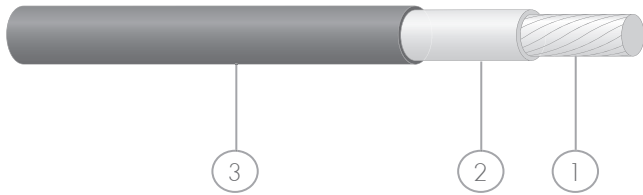

Composition of cable

1. Conductor	stranded tin plated copper, acc. EN 60228, class 5
2. Insulation	RADOX EI 110, colour: white
	RADOX EI 109, colour: white
3. Sheath	RADOX EM 104J, colour: black

Min. bending radius*

Fixed installation	bending angle $\leq 90^\circ$	all D	$2 \times D$
	bending angle $> 90^\circ$	$D \leq 10 \text{ mm}$	$3 \times D$
	bending angle $< 90^\circ$	$D > 10 \text{ mm}$	$4 \times D$
Free installation			$7 \times D$

* Provided that careful and competent handling is used in combination with proven fixture methods.

Application

- RADOX Jumper cables are especially well suited to situations where continuous movement and stringent fire safety requirements have to be taken into account (without torsion loading).

Standards

Standard	Fire protection on railway vehicles	
DIN 5510-2	hazard level	1, 2, 3, 4
EN 45545-2		
UNI CEI 11170-3		

For further technical details please refer to our data sheet.

RADOX[®] Jumper 3600V MM single core

Cross section	Conductor		Core	Cable	Conductor resistance	Capacity*	Fire load	Weight		Item no.
	Construction n × mm	D _{nom.} mm						D mm	D mm	
16	266 × 0.30	6.0	10.6	13.5 ± 0.3	1.22	420	2770	16	33	84119315
25	518 × 0.25	7.6	12.4	15.5 ± 0.3	0.8	490	3600	25	46	84123219
35	700 × 0.25	8.6	13.6	17.0 ± 0.3	0.55	530	4220	32	58	84123220
50	854 × 0.30	10.9	16.5	20.5 ± 0.3	0.38	590	5710	45	82	84123221
70	1008 × 0.30	12.2	18.0	22.0 ± 0.3	0.27	630	6830	63	106	84123222
95	1316 × 0.30	14.1	20.3	24.5 ± 0.4	0.21	670	7660	82	134	84124429
120	960 × 0.40	16.2	22.5	27.5 ± 0.4	0.16	740	10310	109	174	84124430
150	880 × 0.40 + 588 × 0.30	17.6	24.2	29.0 ± 0.4	0.13	760	11230	136	207	84123223
185	1520 × 0.40	19.7	26.3	31.5 ± 0.4	0.11	810	12420	172	251	84124426

* capacity in water, typical value

MM: insulation and sheath material designation according to EN 50264-1

RADOX® Jumper 3600V OM S

Conductor	EN 60228, class 5	Voltage rating	3600/6000 V AC
Number of conductors	1		5400/9000 V DC
Cross section	16 - 185 mm ²	Temperature range	-40 to +110 °C

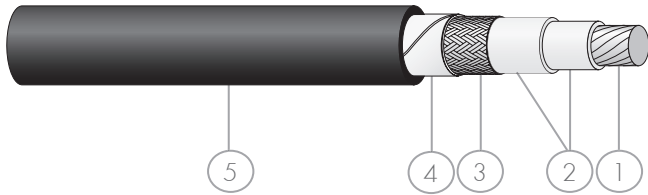

Composition of cable

1. Conductor	stranded tin plated copper, acc. to EN 60228, class 5
2. Insulation	RADOX EI 110, colour: white RADOX EI 109, colour: white
3. EMC screen	tin plated copper braid
4. Separator	tape
5. Sheath	RADOX EM 104 J, colour: black

Min. bending radius*

Fixed installation	bending angle $\leq 90^\circ$	all D	2 × D
	bending angle $> 90^\circ$	D ≤ 10 mm	3 × D
	bending angle $< 90^\circ$	D > 10 mm	4 × D
Free installation			10 × D

* Provided that careful and competent handling is used in combination with proven fixture methods.

Application

- RADOX Jumper cables are for use in rolling stock where permanent bending stresses occur during service, e. g. as jumper cable, body drop cable etc., without torsional stress.

Standards

Standard	Fire protection on railway vehicles	
DIN 5510-2	hazard level	1, 2, 3, 4
EN 45545-2		
UNI CEI 11170-3		

For further technical details please refer to our data sheet.

single core, screened

Cross section	Conductor		Core		Screen		Cable		Conductor resistance		Z_T	Cap-acity*	Fire load	Weight		Item no.
	mm ²	Construction n × mm	D _{nom.} mm	D mm	D _{max.} mm	mm ²	D mm	Cond. R ₂₀ max. Ω/km	Screen R ₂₀ max. Ω/km	max. mΩ/m				C pF/m	nom. kJ/m	
16	266 × 0.30	6.0	10.6	11.3	3.9	14.5 ± 0.3	1.22	7.54	250	420	2950	21	40	84116591		
25	518 × 0.25	7.6	12.4	13.3	5.5	16.5 ± 0.3	0.80	5.40	250	490	3700	31	55	84116592		
35	700 × 0.25	8.6	13.6	14.5	4.8	18.0 ± 0.3	0.55	7.24	320	530	4320	39	67	84120466		
50	854 × 0.30	10.9	16.5	17.4	6.3	21.5 ± 0.3	0.39	4.91	250	590	6215	55	95	84103131		
70	1008 × 0.30	12.2	18.0	18.9	8.3	23.0 ± 0.3	0.27	3.41	250	630	7480	75	118	84120693		
95	1316 × 0.30	14.1	20.3	21.4	10.6	26.0 ± 0.5	0.21	2.70	250	670	9030	96	151	84121058		
120	960 × 0.40	16.2	22.5	23.4	8.3	28.5 ± 0.5	0.16	3.75	250	740	10395	121	188	84117907		
150	880 × 0.40 + 588 × 0.30	17.6	24.2	25.1	9.5	30.0 ± 0.5	0.13	3.16	250	760	11340	150	222	84121069		
185	1520 × 0.40	19.7	26.3	27.6	16.6	33.0 ± 0.5	0.11	1.74	150	810	12475	196	278	84116587		

* capacity conductor/screen typical value

- O: insulation material designation according to EN 50264-1
- M: material designation according to EN 50264-1
- S: metallic screen braid

RADOX® Jumper 3600V OM S T

Conductor	EN 60228, class 5	Voltage rating	3600/6000 V AC
Number of conductors	1		5400/9000 V DC
Cross section	16 - 185 mm ²	Temperature range	-40 to +110 °C

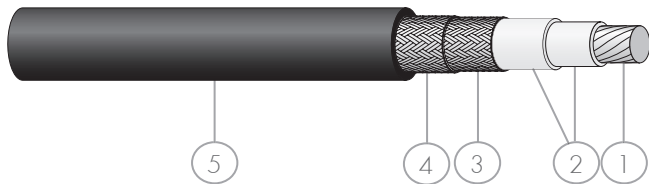

Composition of cable

1. Conductor	stranded tin plated copper, acc. to EN 60228, class 5
2. Insulation	RADOX EI 110, colour: white RADOX EI 109, colour: white
3. EMC screen	tin plated copper braid
4. Torsion protection	textile braid
5. Sheath	RADOX EM 104 J, colour: black

Min. bending radius*

Fixed installation	bending angle $\leq 90^\circ$	all D	2 × D
	bending angle $> 90^\circ$	D ≤ 10 mm	3 × D
	bending angle $< 90^\circ$	D > 10 mm	4 × D
Free installation			10 × D

* Provided that careful and competent handling is used in combination with proven fixture methods.

Application

- RADOX Jumper cables are for use in rolling stock where permanent bending stresses with torsion loading occur during service, e. g. as jumper cable, body drop cable etc., with torsional stress.

Standards

Standard	Fire protection on railway vehicles	
DIN 5510-2	hazard level	1, 2, 3, 4
EN 45545-2		
UNI CEI 11170-3		

For further technical details please refer to our data sheet.

single core, screened, with torsion protection

Cross section	Conductor		Core	Screen		Cable	Conductor resistance		Z_T	Capa- city*	Fire load	Weight		Item no.
	Construction $n \times \text{mm}$	$D_{\text{nom.}}$ mm		D mm	$D_{\text{max.}}$ mm		mm^2	D mm				Cond. $R_{20 \text{ max.}}$ Ω/km	Screen $R_{20 \text{ max.}}$ Ω/km	
16	266 × 0.30	6.0	10.6	11.3	3.9	16.0 ± 0.3	1.22	7.54	250	420	3670	21	45	84116593
25	518 × 0.25	7.6	12.4	13.3	5.5	17.5 ± 0.3	0.80	5.40	250	490	4160	31	58	84121092
35	700 × 0.25	8.6	13.6	14.5	4.8	19.0 ± 0.4	0.55	7.24	320	530	4820	39	71	84121106
50	854 × 0.30	10.9	16.5	17.4	6.3	22.5 ± 0.4	0.39	4.91	250	590	6670	54	98	84121114
70	1008 × 0.30	12.2	18.0	18.9	8.3	24.0 ± 0.4	0.27	3.41	250	630	7610	74	123	84121116
95	1316 × 0.30	14.1	20.3	21.4	10.6	27.0 ± 0.5	0.21	2.70	250	670	9290	96	157	84121159
120	960 × 0.40	16.2	22.5	23.4	8.3	29.0 ± 0.5	0.16	3.75	250	740	10700	122	190	12586388
150	880 × 0.40 + 588 × 0.30	17.6	24.2	25.1	9.5	31.0 ± 0.5	0.13	3.16	250	760	12180	150	228	84121186
185	1520 × 0.40	19.7	26.3	27.6	16.6	33.5 ± 0.5	0.11	1.74	150	810	13025	196	280	84116594

* capacity conductor/screen typical value

- O: insulation material designation according to EN 50264-1
- M: material designation according to EN 50264-1
- S: metallic screen braid
- T: torsion protection

RADOX® Jumper

multi core cables

Based on the proven RADOX railway signal and power railway cables optimised solutions are designed according to customer specifications.

Recommended RADOX cores/cables

• 600 V AC	up to 4 mm ² from 4 mm ²	RADOX TENUIS-TW 600V M RADOX 3 GWK 600V
• 1800 V AC	up to 10 mm ² from 16 mm ²	RADOX 4 GWK AX 1800V M RADOX Jumper 1800V M

Types

- With or without EMC screen
- With or without torsion protection system
- With RADOX EM 104 J sheath material

Application

- RADOX Jumper cables for demanding applications where movements with enhanced fire safety requirements are required.

Features

- Resistance to oil, fuel and weathering
- Very flexible
- Mechanically robust
- Individually configurable
- Meets the common railway fire safety requirements DIN 5510-2

Benefits

- Long operation time
- Customised conduit solutions
- Space and weight savings

RADOX® Jumper

multi core cables

HUBER+SUHNER's wide product range also enables us to combine the following transmission technologies in a single RADOX Jumper cable (hybrid solutions).

- Signal and power transmission
- Radio frequency transmission
- Fiberoptic transmission

These technologies are part of our strategic core business. This enables us, together with our customers, to create complete solutions tailored to the needs of their specific applications. The dynamic rail sector is one of the main beneficiaries of these powerful technological skills.

In addition to standard and customised cables HUBER+SUHNER can also offer complete harnessed solutions.

Please find further information on page 142.





RADOX® Databus cables

HUBER+SUHNER designs and produces a wide range of RADOX Databus cables.

These RADOX Databus cables are specially designed for the demanding rolling stock requirements.

Our sortiment includes:

90 ohm cables

- RADOX USB 2.0

100 ohm cables

- RADOX 100 ohm
- RADOX Railcat CAT5e
- RADOX Railcat CAT7

120 ohm cables

- RADOX MVB - databus cables (multi vehicle bus)
- RADOX UIC - databus cables (international union of railways)
- RADOX WTB - databus cables (wire train bus)
- RADOX CAN - databus cables (controller area networks)

Features

- Electron beam RADOX material doesn't melt and flow at high temperatures
- Halogen free and flame retardant
- Excellent data transmission performances
- Excellent screening effectiveness
- High resistance to heat, cold, ozone and weathering
- Easy to strip
- Soldering resistant

For technical data please refer to our data sheets.

RADOX® Databus 90 OHM USB

General features

Halogen-free, electron-beam cross-linked cable with improved behaviour in case of fire, easy to strip, soldering resistant and flexible. The RADOX Databus 90 Ohm USB cable fulfils the demanding requirements of fire protection standard EN 45545-2.

Application

The cable can be used for fixed installation in rail vehicles or for mechanically protected installation under alternating bending stress. Universal Serial Bus (USB 2.0) cable to connect computer with external devices.

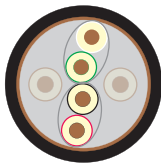

RADOX DATABUS 90 OHM 4C XM S USB

1. pair 2 × 28 AWG	conductor: flexible tin plated copper insulation: RADOX COM colours: white, green
2. pair 2 × 24 AWG	conductor: flexible tin plated copper insulation: RADOX COM colours: black, red
EMC screen	Al-tape with synthetic coating tin plated copper braid
Sheath	RADOX EM 104, schwarz
Cable diameter	4.7 ± 0.4 mm
Item no.	85019834

Features

- Developed and tested for the railway market
- Reliable transmission at high data rates
- RADOX EM 104 sheath material, according to EN 50264-1
- Flame retardant, halogen free, low smoke
- Easy to strip

Standards

Norm	Fire protection on railway vehicles	
DIN 5510-2	hazard level	1, 2, 3, 4
EN 45545-2		
UNI CEI 11170-3		

For further technical details please refer to our data sheet.

General features

Halogen free electron beam cross linked cables with improved behaviour in case of fire, easy to strip, soldering iron resistant and flexible. They comply with the requirements of standard EN 50288-2-2 and substantive fire safety requirements.

Application

The cables are intended for fixed installation in rail vehicles or for applications in which a limited alternating bending stress occurs during service.

Selection guide

Cross section: 22 AWG	(1)	(2)	(3)	(4)	(5)	(6)
Conductor	silver plated	silver plated	tin plated	silver plated	silver plated	tin plated
Sheath conductor	black	blue	blue	black	blue	blue
Cable diameter	6.6 mm	6.6 mm	6.6 mm	7.25 mm	7.25 mm	7.25 mm
Connector	RJ 45/M 12	RJ 45/M 12	RJ 45/M 12	M 12	M 12	M 12

Features

Standard wall				X	X	X
Reduced wall	X	X	X			
ECO			X			X
Item no.	12584038	85068348	85065038	12568935	85068347	84142178

Cross section: 0.5 mm ²	(7)	(8)
Conductor	tin plated	tin plated
Sheath conductor	black	blue
Cable diameter	8.3 mm	8.3 mm
Connector	M 12	M 12

Features

Standard wall	X	X
Reduced wall		
ECO		
Item no.	12585489	85068349

RADOX® Railcat CAT5e

Databus

(1)



RADOX Railcat CAT5e 100 ohm 4 × 22 AWG XM S RW

Conductor	stranded, silver plated copper
Insulation	RADOX FOAM
Colours	white-blue, orange-yellow
Number of cores	4
Cross section	22 AWG
Construction	quad
EMC screen	aluminium tape, laminated (overall)
EMC screen	braid, tin plated copper (overall)
Sheath	RADOX EM 104, black
Cable diameter	6.6 ± 0.4 mm
Item no.	12584038

(2)



RADOX Railcat CAT5e 100 ohm 4 × 22 AWG XM S RW

Conductor	stranded, silver plated copper
Insulation	RADOX FOAM
Colours	white-blue, orange-yellow
Number of cores	4
Cross section	22 AWG
Construction	quad
EMC screen	aluminium tape, laminated (overall)
EMC screen	braid, tin plated copper (overall)
Sheath	RADOX EM 104, blue
Cable diameter	6.6 ± 0.4 mm
Item no.	85068348

RADOX® Railcat CAT5e

(3)

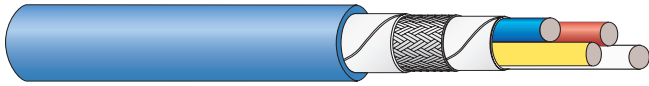

RADOX Railcat CAT5e 100 ohm 4 × 22 AWG XM S RW E

Conductor	stranded, silver plated copper
Insulation	RADOX FOAM
Colours	white-blue, orange-yellow
Number of cores	4
Cross section	22 AWG
Construction	quad
EMC screen	aluminium tape, laminated (overall)
EMC screen	braid, tin plated copper (overall)
Sheath	RADOX EM 104, blue
Cable diameter	6.6 ± 0.4 mm
Item no.	85065038

(4)



RADOX Railcat CAT5e 100 ohm 4 × 22 AWG XM S

Conductor	stranded, silver plated copper
Insulation	RADOX COM
Colours	white-blue, orange-yellow
Number of cores	4
Cross section	22 AWG
Construction	quad
EMC screen	aluminium tape, laminated (overall)
EMC screen	braid, tin plated copper (overall)
Sheath	RADOX EM 104, black
Cable diameter	7.25 ± 0.3 mm
Item no.	12568935

- X: material not according to EN 50264-1
- M: material designation according to EN 50264-1
- S: metallic screen braid
- RW: reduced insulation wall thickness
- E: ECO-version

(5)

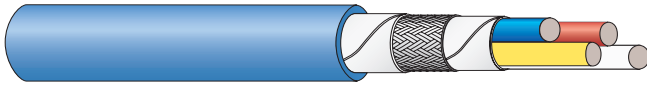

RADOX Railcat CAT5e 100 ohm 4 × 22 AWG XM S

Conductor	stranded, silver plated copper
Insulation	RADOX COM
Colours	white-blue, orange-yellow
Number of cores	4
Cross section	22 AWG
Construction	quad
EMC screen	aluminium tape, laminated (overall)
EMC screen	braid, tin plated copper (overall)
Sheath	RADOX EM 104, blue
Cable diameter	7.25 ± 0.3 mm
Item no.	85068347

(6)

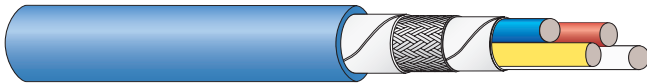

RADOX Railcat CAT5e 100 Ohm 4 × 22 AWG XM S E

Conductor	stranded, tin plated copper
Insulation	RADOX COM
Colours	white-blue, orange-yellow
Number of cores	4
Cross section	22 AWG
Construction	quad
EMC screen	aluminium tape, laminated (overall)
EMC screen	braid, tin plated copper
Sheath	RADOX EM 104, blue
Cable diameter	7.25 ± 0.3 mm
Item no.	84142178

- X: material not according to EN 50264-1
- M: material designation according to EN 50264-1
- S: metallic screen braid
- RW: reduced insulation wall thickness
- E: ECO-version

RADOX® Railcat CAT5e

(7)



RADOX Railcat CAT5e 100 ohm 4 × 0.5 XM S

Conductor	stranded, tin plated copper
Insulation	RADOX COM
Colours	white-blue, orange-yellow
Number of cores	4
Cross section	0.5 mm ²
Construction	quad
EMC screen	aluminium tape, laminated (overall)
EMC screen	braid, tin plated copper (overall)
Sheath	RADOX EM 104, black
Cable diameter	8.3 ± 0.3 mm
Item no.	12585489

(8)



RADOX Railcat CAT5e 100 ohm 4 × 0.5 XM S E

Conductor	stranded, tin plated copper
Insulation	RADOX COM
Colours	white-blue, orange-yellow
Number of cores	4
Cross section	0.5 mm ²
Construction	quad
EMC screen	aluminium tape, laminated (overall)
EMC screen	braid, tin plated copper (overall)
Sheath	RADOX EM 104, blue
Cable diameter	8.3 ± 0.3 mm
Item no.	85068349

- X: material not according to EN 50264-1
- M: material designation according to EN 50264-1
- S: metallic screen braid
- RW: reduced insulation wall thickness
- E: ECO-version

Technical data

RADOX RALCAT CAT5e		4 × 22 AWG XM S				4 × 0.5 XM S
		RW	RW E	-	-	
Item Nr.	black	12584038 (1)	-	12568935 (4)	-	12585489 (7)
	blue	85068348 (2)	85065038 (3)	85068347 (5)	84142178 (6)	85068349 (8)
Conductor resistance at 20 °C	Ω/km	54.4	54.4	54.4	54.4	≤ 40.1
Resistance unbalanced at 20 °C	Ω/km	≤ 1.1	≤ 1.1	≤ 1.1	≤ 1.1	≤ 1.1
Voltage rating	V AC	300	300	300	300	300
Test voltage	V AC	2000	2000	2000	2000	2000
Transfer impedance, f ≤ 30 MHz	mΩ/m	200	200	200	200	200
Characteristic impedance, f = 100 MHz	Ω	100 ± 5	100 ± 5	100 ± 5	100 ± 5	100 ± 5
Signal propagation	%	75	75	66	66	66
Capacitance						
- Core/core	pF/m	≤ 65	≤ 65	≤ 65	≤ 65	≤ 65
- Core/screen	pF/m	≤ 100	≤ 100	≤ 100	≤ 100	≤ 100
Temperature range						
- fixed installation	°C	-50 bis +90	-50 bis +90	-50 bis +90	-50 bis +90	-50 bis +90
- sporadic movement	°C	-25 bis +90	-25 bis +90	-25 bis +90	-25 bis +90	-25 bis +90
Min. bending radius						
- fixed installation	Kabel Ø	6 ×	6 ×	6 ×	6 ×	6 ×
- sporadic movement	Kabel Ø	-	-	10 ×	10 ×	-
Cable weight approx.	kg/100 m	7.0	7.0	8.1	8.1	10.2
Cable outer diameter	mm	6.6	6.6	7.25	7.25	8.30
Suitable connectors		RJ 45/M12	RJ 45/M12	M12	M12	M12

Standards

Standard	Fire protection on railway vehicles	
BS 6853	category	int. Ia, Ib, II/ext. Ia, Ib, II
DIN 5510-2	hazard level	1, 2, 3, 4
EN 45545-2		
GOST 31565		
NFF 16-101	class, category	C/F0, int. A1, A2, B/ext. A1, A2, B
UNI CEI 11170-3		

For further technical details please refer to our data sheet.

General features

CAT7, a databus cable for ethernet network connections of up to 10 gigabits. The 4-pair cable, specially developed for the railway market, fulfils its demanding environmental requirements and fire protection specifications in line with DIN 5510-2 and EN 45545-2 and NF F 16-101.

Application

The new cable is best suited for use as a backbone for railway vehicles and enables a reliable link to all connected systems and devices. It is available as 4 × 2 × 24 AWG and supports flexible routing thanks to its reduced dimensions. Cable can be used for permanent alternating bending stress in connection with inter-vehicle jumper solution from HUBER+SUHNER

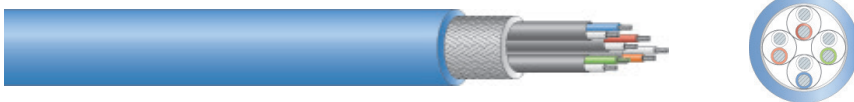

RADOX Railcat CAT7 4 × (2 × 24 AWG) XM S

Conductor	stranded, tin plated copper
Insulation	RADOX FOAM
Colours	white/orange-orange, white/green-green, white/brown-brown, white/blue-blue
Number of cores	8
Cross section	24 AWG
Construction	4 pairs
EMC screen	aluminium tape, laminated (over pair)
EMC screen	braid, tin plated (overall)
Sheath	RADOX EM 104, blue
Cable diameter	8.1 ± 0.5 mm
Item no.	84124806

Features

- Developed and tested for the railway market
- Reliable transmission at high data rates, CAT7
- Meet the electrical requirements of EN 50288-4-2 and IEC 61156-6 cat. 7
- RADOX EM 104 sheath material, according to EN 50264-1
- Flame retardant, halogen free, low smoke
- Easy to strip
- Easily recognised thanks to blue cable jacket

Standards

Standard	Fire protection on railway vehicles	
BS 6853	category	int. Ia, Ib, II/ext. Ia, Ib, II
DIN 5510-2	hazard level	1, 2, 3, 4
EN 45545-2		
NF F 16-101	class, category	C/F0, int. A1, A2, B/ext. A1, A2, B
NFPA 130		
UNI CEI 11170-3		

For further technical details please refer to our data sheet.

RADOX® Databus 120 ohm XM S EN

General features

Halogen free electron beam cross linked cables with improved behaviour in case of fire, easy to strip, soldering iron resistant and flexible. Symmetric 120 ohm databus with excellent transfer properties at high frequencies.

RADOX Databus 120 ohm XM S EN meet the demanding requirements of fire safety standards EN 45545-2.

Application

For protected connections of fixed and sporadic moving parts inside and outside of rolling stock.

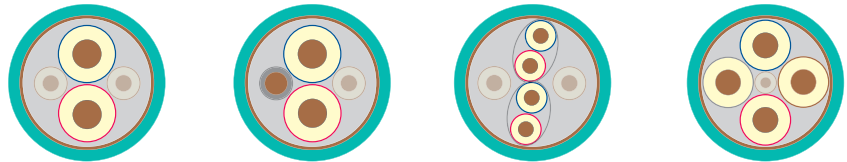

Construction		$2 \times 0.5 \text{ mm}^2$	$2 \times 0.5 \text{ mm}^2 + 0.5 \text{ mm}^2$	$2 \times 2 \times 0.5 \text{ mm}^2$	$4 \times 0.5 \text{ mm}^2$	
Item no.		85004176	84138531	85003600	85001338	
Conductor	(databus)	stranded, tin plated				
	cross section	mm^2	0.5			
	diameter	mm	0.89			
Insulation		RADOX FOAM				
	diameter	mm	2.3	2.3	1.85	2.3
	core colours		blue-red	blue-red	blue-red 1 blue-red 2	blue-red brown-grey
Additional cores		mm^2	no	$1 \times 0.5 \text{ mm}^2$	no	no
	diameter	mm	-	0.89	-	-
	insulation		-	RADOX TI 301	-	-
	colour		-	white	-	-
Cable construction	layer		pair	pair	pair	4-er
	screening		Cu braid	Cu braid	Cu braid	Cu braid
	sheath diameter	mm	RADOX EM 104 7.8 ± 0.3	RADOX EM 104 7.8 ± 0.3	RADOX EM 104 $11.5 \pm 0.4 \text{ mm}$	RADOX EM 104 8.2 ± 0.3
	colour		turquoise	turquoise	turquoise	turquoise

RADOX® Databus 120 ohm XM S EN

Technical data

Construction		2 × 0.5 mm ²	2 × 0.5 + 0.5 mm ²	2 × 2 × 0.5 mm ²	4 × 0.5 mm ²
Item no.		85004176	84138531	85003600	85001338
Conductor resistance at 20 °C	Ω/km	40.1			
Insulation resistance at 20 °C	MΩ/km	100			
Capacitance core/core	pF/m	46			
Impedance	Ω	120 ± 12			
Attenuation nom. at 3 MHz	dB/km	≤ 20			
Voltage rating					
- Databus	V AC	300			
- Control wire	V AC	600			

Fire load	kJ/m	970	955	2005	1055
Cable weight	kg/100 m	7.6	8	17.5	9.4
Temperature range	°C	-50 to +90			
Min. bending radius					
- fixed installation	cable Ø	6 × D			
- sporadic movement	cable Ø	10 × D			

Application				
MVB	x	x	x	x
CAN	x	x		
RS 485	x		x	x
WTB				
UIC				

Standards

Standard	Fire protection on railway vehicles
DIN 5510-2	hazard level 1, 2, 3, 4
EN 45545-2	
UNI CEI 11170-3	

For further technical details please refer to our data sheet.

RADOX® Databus 120 ohm XM S EN

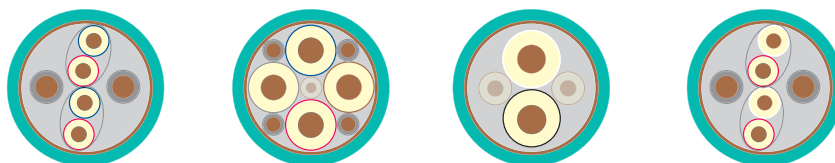

Construction			$2 \times 2 \times 0.5 \text{ mm}^2 + 2 \times 0.5 \text{ mm}^2$	$4 \times 0.5 \text{ mm}^2 + 4 \times 0.25 \text{ mm}^2$	$2 \times 0.75 \text{ mm}^2$	$2 \times 2 \times 0.75 \text{ mm}^2$
Item no.			85004177	85004187	84138532	85001288
Conductor	(databus)		stranded, tin plated			
	cross section	mm ²	0.5	0.5	0.75	0.75
	diameter	mm	0.89	0.89	1.1	1.1
Insulation			RADOX FOAM	RADOX FOAM	RADOX FOAM	RADOX FOAM
	diameter	mm	1.85	2.3	2.65	2.3
	core colours		blue-red 1 blue-red 2	blue-red brown-grey	white-black	white-red 1 white-red 2
Additional cores		mm ²	2×0.5	4×0.25	no	no
	diameter	mm	0.89	0.6	-	-
	insulation		RADOX EI 303	RADOX EI 303	-	-
	colour		white	white	-	-
Cable construction	layer		pair	4-er	pair	pair
	screening		Cu braid	Cu braid	Cu braid	Cu braid
	sheath diameter	mm	RADOX EM 104 11.5 ± 0.4	RADOX EM 104 8.2 ± 0.3	RADOX EM 104 8.5 ± 0.3	RADOX EM 104 12.8 ± 0.4
	colour		turquoise	turquoise	turquoise	turquoise

RADOX® Databus 120 ohm XM S EN

Technical data

Construction		2 × 2 × 0.5 + 2 × 0.5 mm ²	4 × 0.5 + 4 × 0.25 mm ²	2 × 0.75 mm ²	2 × 2 × 0.75 mm ²
Item no.		85004177	85004187	84138532	85001288
Conductor resistance at 20 °C	Ω/km	40.1	40.1 90.1	27.6	27.6
Insulation resistance at 20 °C	MΩ/km	100			
Capacitance core/core	pF/m	46			
Impedance	Ω	120 ± 12			
Attenuation nom. at 3 MHz	dB/km	≤ 20			
Voltage rating					
- Databus	V AC	300			
- Control wire	V AC	600			

Fire load	kJ/m	1905	1036	860	2320
Cable weight	kg/100 m	19	10	9.4	20
Temperature range	°C	-50 to +90			
Min. bending radius					
- fixed installation	cable Ø	6 × D			
- sporadic movement	cable Ø	10 × D			

Application				
MVB				
CAN	X	X		
RS 485				
WTB			X	X
UIC			X	X

- X: material not according to EN 50264-1
M: material designation according to EN 50264-1
S: metallic screen braid
EN: fulfill fire safety standards EN 45545-2

RADOX® Databus 120 Ohm XM S

General features

Halogen free electron beam cross linked cables with improved behaviour in case of fire, easy to strip, soldering iron resistant and flexible. Symmetric 120 ohm databus with excellent transfer properties at high frequencies.

Application

For protected connections of fixed and sporadic moving parts inside and outside of rolling stock.

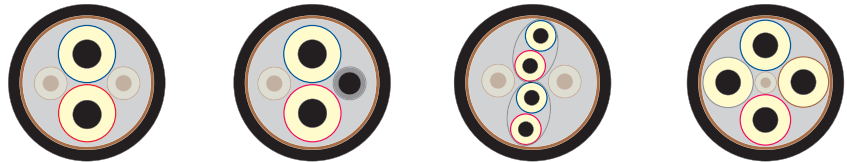

Construction 0.5 mm ²		2 × 0.5 mm ²	2 × 0.5 mm ² + 0.5 mm ²	2 × 2 × 0.5 mm ²	4 × 0.5 mm ²	
Item no.		12552038	12552039	12552040	12552044	
Conductor	(databus)	stranded, tin plated				
	cross section	mm ²	0.5			
	diameter	mm	0.88			
Insulation		RADOX FOAM				
	diameter	mm	2.3			
	core colours		blue-red	blue-red	blue-red brown-grey	blue-red brown-grey
Additional cores		mm ²	-	1 × 0.5 mm ²	-	-
	diameter	mm	-	1.4	-	-
	insulation		-	RADOX GWK	-	-
	colour		-	black	-	-
Cable construction	layer		pair	pair	pair	4-er
	screening		stranded, tin plated			
	sheath diameter	mm	RADOX EM 104 6.8 ± 0.3 black	RADOX EM 104 6.8 ± 0.3 black	RADOX EM 104 11.2 ± 0.4 mm black	RADOX EM 104 7.9 ± 0.3 black

RADOX® Databus 120 Ohm XM S

Technical data

Construction 0.5 mm ²		2 × 0.5 mm ²	2 × 0.5 + 0.5 mm ²	2 × 2 × 0.5 mm ²	4 × 0.5 mm ²
Item no.		12552038	12552039	12552040	12552044
Conductor resistance at 20 °C	Ω/km	40.1			
Insulation resistance at 20 °C	MΩ/km	> 100			
Capacitance core/core	pF/m	≤ 46			
Impedance	Ω	120			
Attenuation nom. at 3 MHz	dB/km	≤ 20			
Voltage rating					
- databus	V AC	300			
- control wire	V AC	600			
Fire load	kJ/m	775	741	1840	976
Cable weight	kg/100 m	6.3	6.8	15.4	8.9
Temperature range	°C	-50 to +90			
Min. bending radius					
- fixed installation	cable Ø	3			
- sporadic movement	cable Ø	5			

Application				
MVB	X	X	X	X
CAN	X	X	X	
RS 485	X	X	X	X

Standard

Standard	Fire protection on railway vehicles
DIN 5510-2	hazard level 1, 2, 3, 4

For further technical details please refer to our data sheet.

RADOX® Databus 120 Ohm XM S

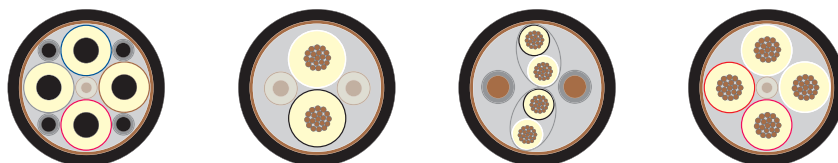

Construction		0.5 mm ²		0.75 mm ²		
		4 × 0.5 mm ² + 4 × 0.25 mm ²		2 × 0.75 mm ²	2 × 2 × 0.75 mm ²	4 × 0.75 mm ²
Item no.		12553902		12552469	12551865	12562589
Conductor	(databus)	stranded, tin plated				
	cross section	mm ²	0.5	0.75	0.75	0.75
	diameter	mm	0.88	1.1	1.1	1.1
Insulation		RADOX FOAM				
	diameter	mm	2.3	2.65	2.65	2.65
	core colours		blue-red brown-grey	white-black	white-black 1 white-black 2	white-red 1 white-red 2
Additional cores		mm ²	4 × 0.25	-	-	-
	diameter	mm	0.6	-	-	-
	insulation		RADOX GWK	-	-	-
	colour		white	-	-	-
Cable construction	layer		4-er	pair	pair	4-er
	screening		stranded, tin plated			
	sheath diameter	mm	RADOX EM 104 7.9 ± 0.3	RADOX EM 104 8.5 ± 0.3	RADOX EM 104 12.8 ± 0.4	RADOX EM 104 9.1 ± 0.3
	colour		black	black	black	black

RADOX® Databus 120 Ohm XM S

Technical Data

Construction		0.5 mm ²		0.75 mm ²	
		4 × 0.5 + 4 × 0.25 mm ²	2 × 0.75 mm ²	2 × 2 × 0.75 mm ²	4 × 0.75 mm ²
Item no.		12553902	12556469	12551865	12562589
Conductor resistance at 20 °C	Ω/km	40.1 90.1	26.7	26.7	26.7
Insulation resistance at 20 °C	MΩ/km	100			
Capacitance core/core	pF/m	46			
Impedance	Ω	120			
Attenuation nom. at 3 MHz	dB/km	20			
Voltage rating - databus - control wire	V AC V AC	300 600			
Fire load	kJ/m	960	855	1900	1195
Cable weight	kg/100 m	9.6	9.7	21.2	12.8
Temperature range	°C	-50 bis +90			
Min. bending radius - fixed installation - sporadic movement	cable Ø cable Ø	4 5			

Application			
MVB	X		
WTB		X	X
UIC		X	X

Standard

Standard	Fire protection on railway vehicles
DIN 5510-2	hazard level 1, 2, 3, 4

For further technical details please refer to our data sheet.



RADOX® FR cables

fire resistant

Effective and economical – simply use RADOX FR safety cables wherever a high level of safety is a priority. RADOX FR cables maintain circuit integrity in case of a fire situation ensuring that essential circuits maintain operational.

Our sortiment includes:

Single cores

- Thin wall, 300 V
 - RADOX 3 GKW 300V M FR RW
- Reduced wall, 600 V
 - RADOX 3 GKW 600V FR
- Reduced wall, 1800 V
 - RADOX 4 GKW-AX 1800V M FR

Multi cores

- Thin wall, 300 V
 - RADOX 3 GKW 300V MM FR RW
 - RADOX 3 GKW 300V MM S FR RW
- Reduced wall, 600 V
 - RADOX 3 GKW 600V XM FR

Features

- Fire resistant
- Flame retardance
- Low smoke density
- Low toxicity index
- Resistance to high temperatures

RADOX® 3 GKW 300V M FR RW

single core

Conductor	EN 60228, class 5	Voltage rating	300/500 V AC
Number of conductors	1		450/750 V DC
Cross section	1.0 – 2.5 mm ²	Temperature range	–50 to +120 °C

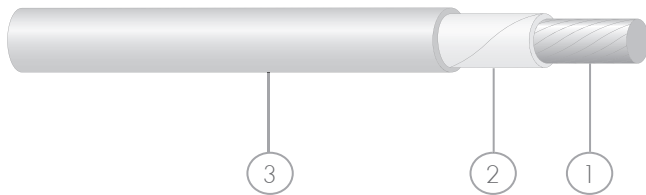

Composition of cable

1. Conductor	stranded tin plated copper
2. Flame barrier	MICA tape
3. Insulation	RADOX EI 201, colour: grey

Characteristics and specialities

- Meets requirement for circuit integrity in case of fire
- Excellent resistance to high and low temperature, ozone and weathering
- Soldering iron resistant
- Easy to strip
- Flexible

Application

- For applications where circuit integrity is required.
- Especially suitable as compact lead wires for systems inside railway rolling stock at fixed or sporadic moving installations.
- Recommended for the installation are the standards EN 50355 and EN 50343.

Standards

Standard	Fire protection on railway vehicles	
DIN 5510-2	hazard level	1, 2, 3, 4
EN 50200	circuit integrity in case of fire	30 min.
EN 45545-2		
GOST 31565		
UNI CEI 11170-3		

For further technical details please refer to our data sheet.

RADOX® 3 GKW 300V M FR RW

single core

Cross section	Conductor		Insulation thickness	Core	Conductor resistance	Capacity*	Fire load	Weight		Colour	Item no.
	Construction n × mm	D _{nom.} mm						mm min.	D mm		
1	37 × 0.18	1.22	0.35	2.50 ± 0.10	20.0	360	64	0.9	1.4	grey	12564873
1.5	30 × 0.25	1.50	0.35	2.80 ± 0.10	13.7	430	73	1.3	1.9	grey	12564623
2.5	50 × 0.25	1.95	0.35	3.20 ± 0.10	8.21	455	85	2.2	2.9	grey	12564625

* capacity in water, typical value

M: material designation according to EN 50264-1

FR: fire resistant: maintain circuit integrity

RW: reduced insulation wall thickness

RADOX® 3 GKW 300V MM FR RW

multi core

Conductor	EN 60228, class 5	Voltage rating	300/500 V AC
Number of conductors	2 - ...		450/750 V DC
Cross section	0.5 - 2.5 mm ²	Temperature range	-50 to +120 °C

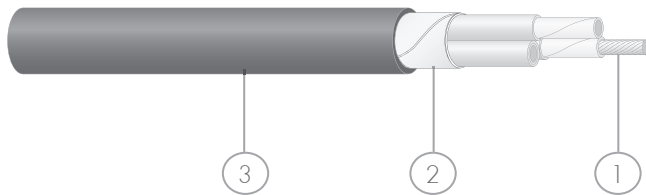

Composition of cable

1. Cores	3 GKW 300V M FR RW colours: grey, numbered optional green-yellow
2. Separator	tape
3. Sheath	RADOX EM 104, colour: black

Characteristics and specialities

- Meets requirement for circuit integrity in case of fire
- Excellent resistance to high and low temperatures
- Resistance to oil, ozone and weathering
- Easy to strip
- Flexible

Application

- For applications where circuit integrity is required.
- Especially suitable as compact lead wires for systems inside railway rolling stock at fixed or sporadic moving installations.
- Recommended for the installation are the standards EN 50355 and EN 50343.

Standards

Standard	Fire protection on railway vehicles	
DIN 5510-2	hazard level	1, 2, 3, 4
EN 50200, EN 50362	circuit integrity in case of fire	30 min.
EN 45545-2		
GOST 31565		
NFF 16-101	class, category	C/F0, int. A1, A2, B/ext. A1, A2, B
UNI CEI 11170-3		

For further technical details please refer to our data sheet.

RADOX® 3 GKW 300V MM FR RW

multi core

Construction	Conductor	Core	Cable	Conductor resistance	Capacity*	Fire load	Weight		Item no.
mm ²	D _{nom.} mm	D _{nom.} mm	D mm	R ₂₀ max. Ω/km	CH20 pF/m	nom. kJ/m	Copper kg/100 m	Cable kg/100 m	
3 × 0.5	0.90	2.00	5.8 ± 0.3	40.1	130	345	1.4	4.9	12567511
26 × 0.5	0.90	2.00	14.7 ± 0.5	40.1	130	2020	12	30	12564979
2 × 0.75	1.10	2.25	5.9 ± 0.3	26.7	140	345	1.3	4	12565262
4 × 0.75	1.10	2.25	7.05 ± 0.3	26.7	140	490	2.6	7.5	12564977
8 × 0.75	1.10	2.25	9.3 ± 0.3	26.7	140	980	5.2	13	12565263
2 × 1	1.22	2.50	6.5 ± 0.3	20.0	150	385	1.7	6.1	12566547
2 × 1.5	1.50	2.80	7.1 ± 0.3	13.7	160	420	2.8	8.1	12564629
3 × 1.5	1.50	2.80	7.7 ± 0.3	13.7	160	520	4.1	9.9	12566342
5 G 1.5	1.50	2.80	9.5 ± 0.3	13.7	160	970	6.7	15	12568269
6 × 1.5	1.50	2.80	10.7 ± 0.4	13.7	160	1360	8.1	17	12566341
7 G 1.5	1.50	2.80	10.3 ± 0.4	13.7	160	1000	9.7	19	12564630
12 G 1.5	1.50	2.80	13.8 ± 0.4	13.7	160	1960	16	32	12568270
25 G 1.5	1.50	2.80	19.6 ± 0.5	13.7	160	3270	35	63	12564631
3 G 2.5	1.95	3.20	8.5 ± 0.3	8.21	190	850	6.4	14	12568271
12 G 2.5	1.95	3.20	15.9 ± 0.5	8.21	190	2100	26	46	12568407
25 G 2.5	1.95	3.20	22.2 ± 0.5	8.21	190	3900	59	90	12564632

* capacity in water, typical value

MM: insulation and sheath material designation according to EN 50306-1

FR: fire resistant: maintain circuit integrity

RW: reduced insulation wall thickness

RADOX® 3 GKW 300V MM S FR RW

multi core

Conductor	EN 60228, class 5	Voltage rating	300/500 V AC
Number of conductors	2 - ...		450/750 V DC
Cross section	0.5 - 2.5 mm ²	Temperature range	-50 to +120 °C

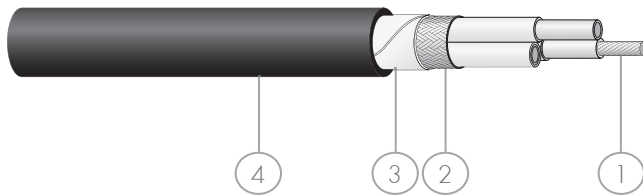

Composition of cable

1. Cores	3 GKW 300V M FR RW colours: grey, numbered optional green-yellow
2. EMC screen	tin plated copper braid
3. Separator	tape
4. Sheath	RADOX EM 104, colour: black

Characteristics and specialities

- Meets requirement for circuit integrity in case of fire
- Excellent resistance to high and low temperatures
- Resistance to oil, ozone and weathering
- Easy to strip
- Flexible

Application

- For applications where circuit integrity is required.
- Especially suitable as compact lead wires for systems inside railway rolling stock at fixed or sporadic moving installations.
- Recommended for the installation are the standards EN 50355 and EN 50343.

Standards

Standard	Fire protection on railway vehicles	
DIN 5510-2	hazard level	1, 2, 3, 4
EN 50200, EN 50362	circuit integrity in case of fire	30 min.
EN 45545-2		
GOST 31565		
NFF 16-101	class, category	C/F0, int. A1, A2, B/ext. A1, A2, B
UNI CEI 11170-3		

For further technical details please refer to our data sheet.

RADOX® 3 GKW 300V MM S FR RW

multi core

Construction mm ²	Conductor D _{nom.} mm	Core			Cable D mm	Conductor resistance R ₂₀ max. Ω/km	ZT max. mΩ/m	Capacity		Fire load nom. kJ/m	Weight		Item no.
		D _{nom.} mm	D _{max.} mm	cross section mm ²				core/ core C pF/m	screen C pF/m		copper kg/ 100 m	cable kg/ 100 m	
2 × 0.5	0.90	2.00	4.6	1.4	6.0 ± 0.3	40.1	150	180	315	405	2.3	5.9	12566709
2 × 2 × 0.5	0.90	2.00	8.2	3.29	10.1 ± 0.4	40.1	70	180	315	935	5	14	12566714
3 × 2 × 0.5	0.90	2.00	8.6	3.85	10.5 ± 0.4	40.1	60	180	315	1190	6.5	17	12585599
4 × 2 × 0.5	0.90	2.00	10.5	5.55	12.5 ± 0.4	40.1	60	180	315	1330	9	21	12585096
6 × 2 × 0.5	0.90	2.00	13	7.9	15.2 ± 0.5	40.1	60	180	315	1865	13	31	12567021
7 × 2 × 0.5	0.90	2.00	11.4	5.9	13.6 ± 0.4	40.1	60	180	315	1560	12	27	12566367
2 × 0.75	1.10	2.25	5.2	1.5	6.4 ± 0.3	26.7	140	190	335	480	2.9	7	12564627
4 × 0.75	1.10	2.25	6.2	2.1	7.5 ± 0.3	26.7	100	190	335	605	4.8	9.7	12564628
6 × 0.75	1.10	2.25	7.6	2.9	9.05 ± 0.3	26.7	80	190	335	895	7.1	14	12568276
8 × 0.75	1.10	2.25	8.4	3.3	10.2 ± 0.4	26.7	70	190	335	980	8.8	17	12566544
12 × 0.75	1.10	2.25	10.5	5.1	12.4 ± 0.4	26.7	60	190	335	1525	13	25	12566278
5 × 2 × 0.75	1.10	2.25	12.5	7.9	14.7 ± 0.4	26.7	60	190	335	1600	14	30	12565935
6 × 2 × 0.75	1.10	2.25	14.3	9.1	16.9 ± 0.5	26.7	55	190	335	2430	17	38	12566366
2 × 1.0	1.22	2.50	5.6	1.7	7.1 ± 0.3	20.0	120	190	335	630	3.6	8.5	12567871
4 × 1.0	1.22	2.50	7.0	2.3	8.5 ± 0.3	20.0	70	190	335	830	6	13	12584298
8 × 1.0	1.22	2.50	10.7	5.55	12.6 ± 0.4	20.0	40	190	335	1905	13	27	12583521
4 × 2 × 1.0	1.22	2.50	12.8	7.1	15.0 ± 0.5	20.0	40	190	335	2085	15	31	12585097
2 × 1.5	1.50	2.80	6.3	2.0	7.8 ± 0.3	13.7	90	200	350	670	4.6	11	12566485
3 × 1.5	1.50	2.80	6.8	2.0	8.3 ± 0.3	13.7	90	200	350	720	6.1	13	12566486
6 × 1.5	1.50	2.80	9.4	3.7	11.3 ± 0.4	13.7	65	200	350	1285	12	23	12566487
12 × 1.5	1.50	2.80	12.7	7.1	15.8 ± 0.5	13.7	40	200	350	2475	23	44	84141395
20 × 1.5	1.50	2.80	16.4	10.2	18.9 ± 0.5	13.7	40	200	350	2940	37	64	12566488
2 × 2.5	1.94	3.20	7.2	7.3	8.8 ± 0.3	8.21	80	200	350	550	7.3	15	12566545

* capacity in water, typical value

MM: insulation and sheath material designation according to EN 50306-1

S: metallic screen braid

FR: fire resistant: maintain circuit integrity

RW: reduced insulation wall thickness

RADOX® 3 GKW 600V FR

single core

Conductor	EN 60228, class 5	Voltage rating	600/1000 V AC
Number of conductors	1		900/1500 V DC
Cross section	1.0 – 150 mm ²	Temperature range	–50 to +120 °C

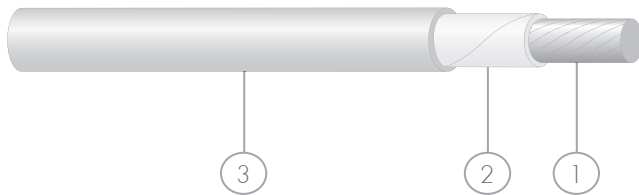

Composition of cable

1. Conductor	stranded tin plated copper
2. Flame barrier	MICA tape
3. Insulation	RADOX EI 201, colour: grey

Characteristics and specialities

- Meets requirement for circuit integrity in case of fire
- Excellent resistance to high and low temperature, ozone and weathering
- Soldering iron resistant
- Easy to strip
- Flexible

Application

- For applications where circuit integrity is required
- Especially suitable as compact lead wires for systems inside railway rolling stock at fixed or sporadic moving installations.
- Recommended for the installation are the standards EN 50355 and EN 50343.

Standards

Standard	Fire protection on railway vehicles	
DIN 5510-2	hazard level	1, 2, 3, 4
EN 50200, EN 50362	circuit integrity in case of fire	30 min.
EN 45545-2		
GOST 31565		
NF F 16-101	Klassierung, Kategorie	C/F0, int. A1, A2, B/ext. A1, A2, B
NFPA 130		

For further technical details please refer to our data sheet.

RADOX® 3 GKW 600V FR

single core

Cross section	Conductor	Core	Conductor resistance	Capacity*	Fire load	Weight		Item no.
mm ²	D _{nom.} mm	D mm	R ₂₀ max. Ω/km	CH20 pF/m	nom. kJ/m	Copper kg/100 m	Cable kg/100 m	
1	1.22	3.15 ± 0.10	20.0	315	200	0.9	2	12566936
1.5	1.50	3.65 ± 0.10	13.7	341	225	1.3	2.4	12566937
2.5	1.95	4.05 ± 0.15	8.21	406	258	2.2	3.7	12566914
4	2.45	4.60 ± 0.15	5.09	478	308	3.4	5.2	12560764
6	2.95	5.30 ± 0.15	3.39	457	316	5.2	7.4	12566938
10	3.90	6.35 ± 0.15	1.95	552	468	9.1	12.4	12566939
16	5.30	8.15 ± 0.15	1.24	627	624	13.5	18	12566940
25	6.60	9.65 ± 0.15	0.795	710	813	20.7	26.3	12566941
35	7.80	10.80 ± 0.20	0.565	828	940	30	36.7	12565134
50	9.30	12.80 ± 0.25	0.393	843	1327	43	52	12567265
70	11.4	15.0 ± 0.25	0.277	970	2010	61.2	74.6	85014837
95	13.9	16.8 ± 0.3	0.210	1000	2460	78.1	94.4	85014869
150	16.8	21.3 ± 0.3	0.132	1125	3530	127	151	12567264

* capacity in water, typical value

FR: fire resistant: maintain circuit integrity

RADOX® 3 GKW 600V XM FR

multi core

Conductor	EN 60228, class 5	Voltage rating	600/1000 V AC
Number of conductors	2 - ...		900/1500 V DC
Cross section	1.5 - 50 mm ²	Temperature range	-50 to +120 °C

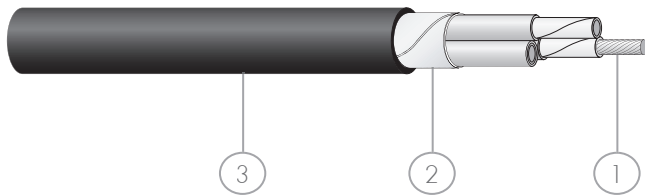

Composition of cable

1. Cores	3 GKW 600V FR colours: grey, numbered optional green-yellow
2. Separator	tape
3. Sheath	RADOX EM 104, colour: black

Characteristics and specialities

- Meets requirement for circuit integrity in case of fire
- Excellent resistance to high and low temperatures
- Resistance to oil, ozone and weathering
- Easy to strip
- Flexible

Application

- For applications where circuit integrity is required.
- Especially suitable as compact lead wires for systems inside railway rolling stock at fixed or sporadic moving installations.
- Recommended for the installation are the standards EN 50355 and EN 50343.

Standards

Standard	Fire protection on railway vehicles	
DIN 5510-2	hazard level	1, 2, 3, 4
EN 50200, EN 50362	circuit integrity in case of fire	30 min.
EN 45545-2		
GOST 31565		

For further technical details please refer to our data sheet.

RADOX® 3 GKW 600V XM FR

multi core

Construction	Conductor	Core	Cable	Conductor resistance	Fire load	Weight		Item no.
mm ²	D _{nom.} mm	D _{nom.} mm	D mm	R ₂₀ max. Ω/km	nom. kJ/m	Copper kg/100 m	Cable kg/100 m	
4 × 0.75	1.1	2.9	8.7 ± 0.3	20.7	980	2.9	10.9	85066141
2 × 1.5	1.49	3.65	8.9 ± 0.3	13.7	1140	2.7	11.5	85023787
4 × 1.5	1.49	3.65	11.1 ± 0.4	13.7	1620	5.4	19.0	85066152
8 × 1.5	1.49	3.65	16.2 ± 0.5	13.7	3800	10.9	40.1	85066211
3 G 2.5	1.95	4.05	10.7 ± 0.4	8.21	1390	6.7	19	12582893
3 × 4	2.45	4.6	11.9 ± 0.3	5.09	1544	10.5	24	12565106
4 × 50	9.3	12.8	36.5 ± 0.7	0.393	15192	174	282	12568900

- X: material not according to EN 50264-1
- M: material designation according to EN 50264-1
- FR: fire resistant: maintain circuit integrity

RADOX® 3 GKW 600V XM S FR

multi core

Conductor	EN 60228, class 5	Voltage rating	600/1000 V AC
Number of conductors	2 - ...		900/1500 V DC
Cross section	1.5 - 50 mm ²	Temperature range	-50 to +120 °C

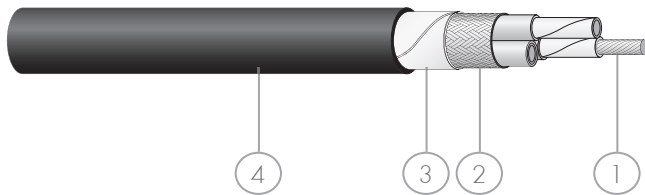

Composition of cable

1. Cores	3 GKW 600V FR colours: grey, numbered optional green-yellow
2. EMC screen	tin plated copper braid
3. Separator	tape
4. Sheath	RADOX EM 104, colour: black

Eigenschaften

- Meets requirement for circuit integrity in case of fire
- Excellent resistance to high and low temperatures, oil, ozone and weathering
- Soldering iron resistant
- Easy to strip
- Flexible

Application

- For applications where circuit integrity is required.
- Especially suitable as compact lead wires for systems inside railway rolling stock at fixed or sporadic moving installations.
- Recommended for the installation are the standards EN 50355 and EN 50343.

Standards

Standard	Fire protection on railway vehicles	
DIN 5510-2	hazard level	1, 2, 3, 4
EN 50200, EN 50362	circuit integrity in case of fire	30 min.
EN 45545-2		
GOST 31565		

For further technical details please refer to our data sheet.

RADOX® 3 GKW 600V XM S FR

multi core

Construction	Conductor	Core	Screen		Cable	Conductor resistance	Fire load	Weight		Item no.
mm ²	D _{nom.} mm	D _{nom.} mm	Dmax. mm	Cross section mm ²	D mm	R ₂₀ max. Ω/km	nom. kJ/m	Copper kg/100 m	Cable kg/100 m	
2 × 1.5	1.49	3.65	8.1	3.38	10.5 ± 0.4	60	1400	5.7	17.1	84096674

- X: material not according to EN 50264-1
- M: material designation according to EN 50264-1
- S: metallic screen braid
- FR: fire resistant: maintain circuit integrity

RADOX® 4 GKW-AX 1800V M FR

single core

Conductor	EN 60228, class 5	Voltage rating	1800/3000 V AC
Number of conductors	1		2700/4500 V DC
Cross section	1.5 - 240 mm ²	Temperature range	-40 to +120 °C

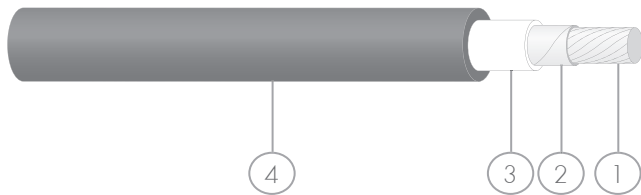

Composition of cable

1. Conductor	stranded tin plated copper
2. Flame barrier	MICA tape
3. Insulation	RADOX EI 110, colour: white
4. Sheath	RADOX EI 109, colour : black

Characteristics and specialities

- Meets requirement for circuit integrity in case of fire
- Resistance to oil, ozone and weathering
- Flexible
- Easy to strip

Application

- For applications where circuit integrity is required.
- Especially suitable as compact lead wires for systems inside railway rolling stock at fixed or sporadic moving installations.
- Recommended for the installation are the standards EN 50355 and EN 50343.

Standards

Standard	Fire protection on railway vehicles	
DIN 5510-2	hazard level	1, 2, 3, 4
EN 50200/EN 50362	circuit integrity in case of fire	30 min. (1030 V AC)
EN 45545-2		
GOST 31565		
UNI CEI 11170-3		

For further technical details please refer to our data sheet.

RADOX® 4 GKW-AX 1800V M FR

single core

Cross section	Conductor		Core	Conductor resistance	Capacity*	Fire load	Weight		Item no.
	Construction n × mm	D _{nom.} mm					D mm	R ₂₀ max. Ω/km	
1.5	37 × 0.23	1.50	3.80 ± 0.10	13.7	249	199	1.3	2.8	12552226
2.5	61 × 0.23	1.95	4.30 ± 0.15	8.21	289	240	2.2	4	12559357
4	61 × 0.29	2.40	4.95 ± 0.15	5.1	330	304	3.5	5.7	12552871
6	84 × 0.30	2.95	5.50 ± 0.15	3.4	362	367	5.2	7.8	12559772
10	80 × 0.40	3.90	6.80 ± 0.15	1.95	417	519	9.1	13	12552228
16	119 × 0.40	5.30	8.60 ± 0.20	1.24	485	849	13.5	19	12555388
25	182 × 0.40	6.60	10.2 ± 0.20	0.8	553	1124	21	25	12559773
35	266 × 0.40	7.80	11.7 ± 0.20	0.57	595	1446	30	40	12560644
50	378 × 0.40	9.30	13.8 ± 0.25	0.39	611	1994	43	57	12560645
70	348 × 0.50	11.4	15.8 ± 0.25	0.28	737	2288	61	77	12552873
95	444 × 0.50	12.9	17.6 ± 0.30	0.21	788	2740	78	97	12560646
120	570 × 0.50	14.9	20.2 ± 0.30	0.16	788	3496	100	124	12552230
150	722 × 0.50	16.8	22.4 ± 0.30	0.13	831	4175	127	155	12562955
185	874 × 0.50	18.3	24.3 ± 0.30	0.11	844	4885	153.7	186	12584028
240	1147 × 0.50	21.1	27.3 ± 0.40	0.082	946	5436	201.7	239	84131740

* capacity in water, typical value

M: material designation according to EN 50264-1

FR: fire resistant: maintain circuit integrity

Fire safety requirements for traction cables

	Cable-Ø mm	Test method	Europe EN 45545-2: 2013 interior cables	Europe EN 50264: 2008
Vertical flame propagation		EN 60332-1-2	50 > L ≤ 540 mm	50 > L ≤ 540 mm
		NF C 032-070, 2.1	-	-
Vertical flame propagation, bunched	D ≥ 12	EN 50266-2-4	L ≤ 2.5 m	L ≤ 2.5 m
	6 < D < 12	EN 50266-2-5 EN 50305, 9.1.1	L ≤ 2.5 m	L ≤ 2.5 m
	D ≤ 6	EN 50305, 9.1.2	L ≤ 1.5 m	L ≤ 1.5 m
		NF C 032-070, 2.2		-
Smoke density		EN 61034-2	HL1: T ≥ 25 % HL2: T ≥ 50 % HL3: T ≥ 70 %	T ≥ 70 %
Toxicity		X10-702-2	-	-
		NF X70-100	-	-
		EN 50305, 9.2	HL1: ITC ≤ 10 HL2: ITC ≤ 10 HL3: ITC ≤ 6	ITC ≤ 3
Corrosivity of combustion gases		EN 50267-2-2	-	pH ≥ 4.3 C ≤ 10 µS/mm
Amount of halogen		EN 50267-2-1	-	HCl + HBr ≤ 0.5 %
Content of fluorine		EN 60684-2, 45.2	-	HF ≤ 0.1 %

overview

Europe			Germany, Austria, Switzerland DIN 5510-2: 2009 interior cables	France, Belgium NFF 16-101: 1988 interior cables	Italy UNI CEI 11170-3: 2005		
EN 50306: 2002							
50 > L ≤ 540 mm			50 > L ≤ 540 mm	-	50 > L ≤ 540 mm		
-			-	50 > L ≤ 540 mm	-		
L ≤ 2.5 m			L ≤ 2.5 m	-	L ≤ 2.5 m		
L ≤ 2.5 m			L ≤ 2.5 m	-	L ≤ 2.5 m		
L ≤ 1.5 m			L ≤ 1.5 m	-	L ≤ 1.5 m		
-			-	L ≤ 300 mm	-		
HL1: no requirements HL2: T ≥ 60 % HL3: T ≥ 70 %			T ≥ 60 %	-	T ≥ 70 %		
-			-	I.F. ≤ 20	-		
-			-		-		
HL 1	sheath	isolation	requirements according to EN 50264 respectively EN 50306		LR1	sheath	isolation
HL 2	-	-			LR2	ITC ≤ 5	ITC ≤ 10
HL 3	ITC ≤ 5	ITC ≤ 10			LR3	ITC ≤ 5	ITC ≤ 10
	ITC ≤ 3	ITC ≤ 6			LR4	ITC ≤ 3	ITC ≤ 6
pH ≥ 4.3 C ≤ 10 μS/mm			pH ≥ 4.3 C ≤ 10 μS/mm		pH ≥ 4.3 C ≤ 10 μS/mm		
HCl + HBr ≤ 0.5 %			HCl + HBr ≤ 0.5 %		HCl + HBr ≤ 0.5 %		
HF ≤ 0.1 %			HF ≤ 0.1 %		-		



Cable systems

Powerful capabilities of a global contractor

The engineering teams of HUBER+SUHNER are made up of highly experienced specialists who have direct access to the comprehensive know-how of the Group.

The Railway Cable Systems unit develops solutions focused on specific customer needs which ensure a high level of safety and functionality. Its uncompromising claim to delivering integral solutions is confirmed time and again by its competence in project management, system engineering, prototyping and volume production. This holds true for national and international projects alike.

In the field of cables, we permanently refine existing products already excellently positioned in the marketplace such as RADOX® railway cables. At the same time, we forge ahead with the development of new successful product families.

Our extensive, worldwide group capabilities benefit all segments of the railway market: from underground and tramways to locomotives for urban and high-speed trains.

As our partner and customer, you will benefit from:

- Our unique global production and distribution network
- Our unique product capabilities in the areas of
 - Low Frequency
 - Radio Frequency
 - Fiber Optics
- Our global project management skills

Picture: HUBER+SUHNER railway cable harness solution

Tailored to your specific needs

Inter-vehicle systems

HUBER+SUHNER supplies complete inter-vehicle systems including designs which combine Low Frequency, Fiber Optics or Radio Frequency technologies. Cables or hybrid cable solutions, pre-assembled units, EMC-optimised solutions and cable systems designed to withstand high dynamic stressing convince our demanding customers and prove their worth in heavy-duty applications.

Cable systems for bogies

Applications with increased requirements in the field of bogies have used our innovative cable and cable system solutions for years.

Coach harnesses

From cable assemblies to complex cable harnesses incorporating power, signal and communication lines, we supply everything from a single source. Optimised and certified processes ensure smooth project flows from development, sourcing and prototyping to volume production.

Cables and harnessing for the following applications:

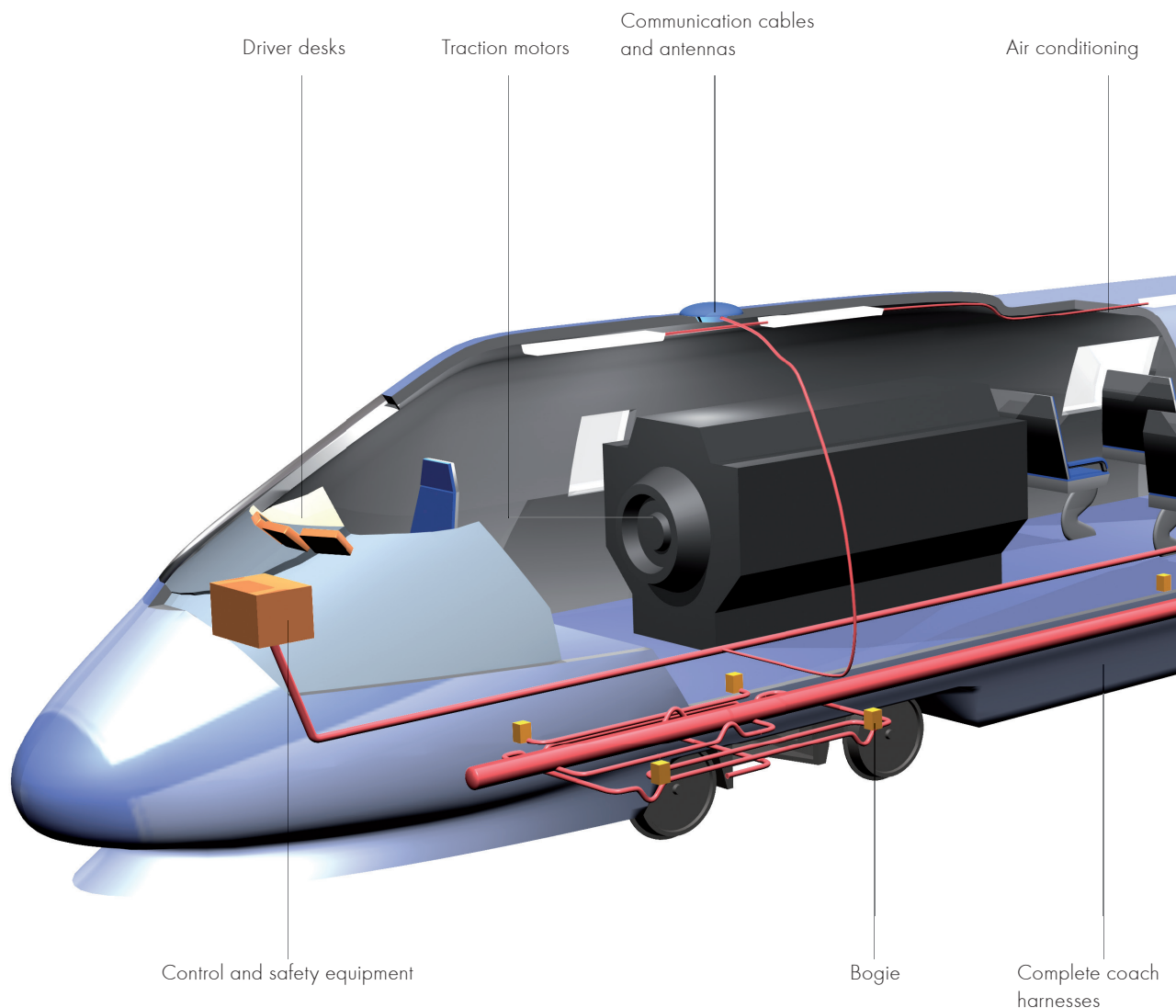

Railcar and locomotive cabling

Solutions developed on the basis of «build to print» or together with our customers satisfy customer requirements the world over.

Cabling of control and safety systems

HUBER+SUHNER will take charge of complete implementation, from procurement to the ready-to-connect and tested assembled units.

Switchgear cabinets

Customised, rail-worthy switchgear and distribution cabinets complete our product portfolio.

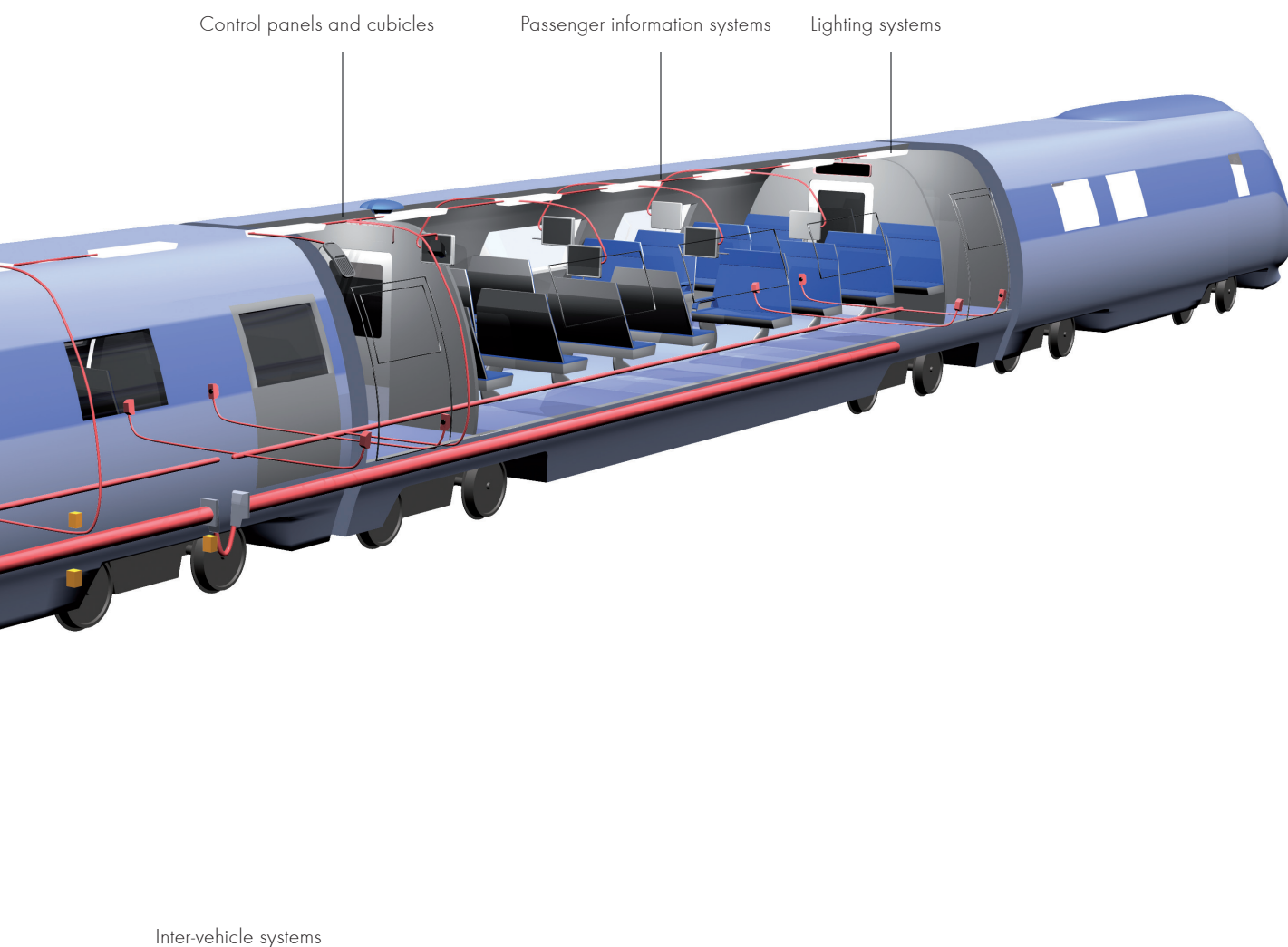

Added value thanks to extensive services

On the train with HUBER+SUHNER

Public railway transport services are increasingly expected to offer networks with an ever-higher level of service and higher speeds, in the areas of both passenger and goods traffic. As a consequence, carriers and system integrators are permanently seeking new, more powerful solutions. Railway Cable Systems is one of these solutions – locally available, competent and just in time.

Mobility with an open future

Equipped with a unique set of technological capabilities from our product portfolio, Railway Cable Systems ensures that its customers around the world will maintain their edge in the marketplace. Innovative services ranging from cable assembly to the development of new products generate the added value that customers need to maintain their competitive edge in a highly competitive environment.

Our integral service package offers you added value

Our business model enables the Railway Cable Systems Unit to enhance the added value that it can offer customers thanks to HUBER+SUHNER railway cable harness. This enables the increasing flexibility and safety quality requirements to be satisfied in the international markets.

Development: HUBER+SUHNER have the capability to take the responsibility of the design and development program according to the needs of the customers partners.

Project management: Designated project responsibility is assured by the support of local HUBER+SUHNER group company.

Prototyping: Ensures process stability guaranteeing smooth transition into volume production.

Volume production: Volume production according to ISO and soon also to the IRIS standard allows reliable and efficient cable assembly processes.

Qualified employees

Experienced engineers and project management specialists form the backbone of our organisation.

In order to maintain its leadership, the Group is committed to its employees.

Top performance has allowed the Group to rise to the illustrious circle of top employers in a number of countries. Current examples include the distinction as «Top Employers 2008 – Shanghai Region» and the German «Top Job» seal of quality.

Market leaders trust our services



STADLER Rail AG

Services provided by HUBER+SUHNER for STADLER Rail AG

- Project evaluation
- Development
- Production
- Logistics

Added value for STADLER Rail AG

- RADOX® railway cables developed to meet specific customer needs
- Tested and optimised solutions
- Quick responses to project changes
- Low project risks
- Just in time deliveries



ALSTOM Transport

Services provided by HUBER+SUHNER for ALSTOM Transport

- Development
- Production
- Logistics

Added value for ALSTOM Transport

- RADOX® railway cables developed to meet specific customer needs
- Tested and optimised solutions
- Quick responses to project changes
- Low project risks
- Just in time deliveries

Market leaders trust our services



BOMBARDIER Transportation

Services provided by HUBER+SUHNER for BOMBARDIER Transportation

- Development
- Production
- Logistics
- Installation support on site

Added value for BOMBARDIER Transportation

- RADOX® railway cables developed to meet specific customer needs
- Tested and optimised solutions
- Cost-effective pre-fabricated solutions
- Low project risks
- Just in time deliveries
- Global production and distribution network



SIEMENS AG

Services provided by HUBER+SUHNER for SIEMENS AG

- Development
- Production
- Logistics

Added value for SIEMENS AG

- Perfectly coordinated HUBER+SUHNER products
- Tested and optimised solutions
- System cable solutions for inter-vehicle systems
- Low project risks
- Just in time deliveries

Inter-vehicle systems

Inter-vehicle systems must satisfy stringent demands, since the cables in motion are subjected to a wide range of different mechanical stresses. These are caused especially by vibration, bending and torsion in addition to occasionally extreme operating conditions and environmental influences. System cables are manufactured on the basis of specific customer needs, taking into account the proven HUBER+SUHNER design guidelines. Manufacturing is fairly time-consuming because the cables pass through several in-line process operations. The earlier HUBER+SUHNER is familiarised with concrete projects, the easier it will be to satisfy the relevant customer needs. As a system provider, HUBER+SUHNER offers professional consulting as early as during the development phase. In order to produce optimal cable design solutions, it makes sense in the project engineering phase to allow the widest possible latitude in terms of how the cores and elements are to be combined in the cables.



© FEDERAL REPUBLIC OF GERMANY
 DEUTSCHES PATENTAMT
 GERMAN PATENT AND TRADEMARK OFFICE

Patent Specification
DE 101 35 971 C1

Int. Cl.:
H 01 R 13/56
 H 01 R 13/58
 H 02 G 15/07
 H 02 G 3/18

File no.: 101 35 971.3-34
 Filing date: 24.7.2001
 Date of disclosure: -
 Date of publication of the granted patent: 30.4.2003

Opposition can be raised within 3 months after publication of the granted patent

Assignee: Huber & Suhner AG, Pfäfers, CH
 Inventor: Casanova, Reto, Pfäfers, CH

Representative(s): Gröneckler, Kinkeldy, Stockmair&Schwanhüsser, 80038 Munich
 Documents cited for the evaluation of patentability:
 DE 37 31 149 C2
 DE 34 17 882 C2
 DE 34 09 350 C2
 DE 92 01 548 U1
 DE 81 01 343 U1

© Cable anti-kink apparatus with strain relief and method for the assembly of such a cable anti-kink apparatus

In a cable anti-kink apparatus with strain relief, a cable with an anti-kink sleeve firmly sealed, particularly extruded, on the cable is fed through the through-hole of a first cable screw connection element with a clearance opening and affixed axially by means of a second cable screw connection element pushed over the cable and the anti-kink sleeve from behind, the second cable screw connection element being able to screw together with the first cable screw connection element and a retaining means affixed between it and the first cable screw connection element, which are mechanically connected with the anti-kink sleeve.
 In such a cable anti-kink apparatus, an improved assembly is achieved in that the outside diameter of the anti-kink sleeve is smaller than the clearance opening of the through-hole of the first cable screw connection element, and in that the retaining means with the anti-kink sleeve comprise detachable, axially engaging retainers.

DE 101 35 971 C1
 FEDERAL PRINTING OFFICE 0303 203180/01/7A 9

Translated by HUBER+SUHNER into English.

HUBER+SUHNER inter-vehicle system



Train-to-ground communication

Wireless communication is an integral part of any modern transportation system. This includes train control and communications, train positioning, mobile communications for internet-on-board and many other applications. HUBER+SUHNER can provide all passive radio frequency components required for wireless applications in the railway, tramway, Metro and bus sector.

A key component for the wireless train-to-ground solution is the roof-top antenna. Roof-top antennas for trains are exposed to harsh environmental conditions and must comply to the following requirements:

- Temperature and vibration requirements according to EN 50155
- Ingress protection level IP 65 and/or IP68
- EMC protection according to EN 50121-3-2
- Fire retardance acc. to EN 45545-2 and NFPA130
- High voltage protection to avoid any high voltage on the RF port when the train is driving underneath a catenary line with a voltage up to 27.5 kV

Sencity®Rail antenna products from HUBER+SUHNER comply to the requirements above and additionally follow the additional design rules:

- All metal parts are grounded according to UIC 533
- Low corrosion design according to MIL-F-14072
- High current protection to avoid any high voltage on the RF port when the catenary line breaks, destroys the antenna radome and touches the antenna element with a short-circuit current up to 40kA/100 ms.
- Wind speed up to 500 km/h
- Low hail impact
- Ingress protection level IP69

GSM-R and Tetra is used for train safety, train control and cab radio systems

ETCS and GSM-R is widely used in Europe. These systems use a dedicated GSM-R cellular based trackside wireless network. For some of these applications also TETRA is used.

2G/3G/4G public cellular networks are used for internet on board and cellular repeaters

Cellular repeaters or cellular routers use the existing 2G/3G/4G public cellular networks to offer a strong cellular signal inside the train or to provide a broadband internet access. The same wireless link is used by the train operator for other applications.

Wifi is used for CBTC and high-performance wireless backhails or even dedicated point-to-point links

An installation of a Wifi trackside based infrastructure for communication based train control (CBTC) is used in the metropolitan railway sector. The same infrastructure is also frequently used for high-speed data transfer between the train and track for Closed Circuit Television (CCTV) or internet-on-board. Point-to-point links are used to transfer data between the vehicle and a nearby infrastructure like a station or depot.

GNSS is used for train position related services

Several application on board of the train use a GNSS receiver on board of the train to provide a service depending on the trains position.

SENCITY® Rail low profile

The SENCITY® Rail low profile antenna family provides an all-in-one wireless communication solution for all type of trains.

SENCITY® Rail low profile antennas meet the special requirements of railway applications with the focus on minimized height. Therefore these products are ideally suited to double-decker trains. They provide electrical protection against the impact of a contact with the overhead line.

Key features:

- Omni-directional roof-top antenna with an extremely rugged mechanical design and 40 mm height
- Multi-band support 790 MHz to 6 GHz
- 2x2 MIMO
- Embedded GNSS antenna with integrated low-noise amplifier*
- High voltage protection (up to 27.5 kV)
- High current protection (up to 40 kA/100ms)
- Works on minimized metal ground plane

Target applications:

- GSM-R
- Internet on board and cellular repeaters using 2G/3G/4G cellular
- Double-deck trains with gauge limitations

*Depends on the model.



SENCITY® Rail

The SENCITY® Rail antenna family provides an all-in-one wireless communication solution for all type of trains.

SENCITY® Rail antennas meet the special requirements of railway applications. They provide electrical protection against the impact of a contact with the overhead line.

Key features:

- Omni-directional roof-top antenna with an extremely rugged mechanical design and 80 mm height*
- Multi-band support 380 MHz to 6 GHz*
- 2x2 and 4x4 MIMO*
- Embedded GNSS antenna with integrated low-noise amplifier*
- High-voltage protection (up to 27.5 kV)
- High current protection (up to 40 kA/125 ms or 70kA/50 ms)*
- Works without metal ground plane above 790 MHz
- Advanced mounting options

Target applications:

- GSM-R or TETRA
- Internet on board and cellular repeaters using 2G/3G/4G cellular
- Installations on minimum metal ground or non-metal materials
- Multiple cellular or Wifi MIMO configurations

*Depends on the model.



SENCITY® Rail antenna family

Type designation		Antenna family	Remarks	Freq. min. MHz	Freq. max. MHz	Gain dBi	Pol.
SISO							
1399.99.0026		SWA-0459/360/4/25/DFRX30	Single port multi-band Tetra/cellular/Wifi antenna - embedded GNSS antenna - 150 mm height	380 1350 1700 3300 4900 1574	960 1525 2700 4900 6425 1576	3.0 7.5 7.5 7.0 8.0	vertical
1399.99.0120		SWA-0859/360/4/0/DFRX30_2	Single port multi-band cellular/Wifi antenna - embedded GNSS antenna - 90 mm height	698 1350 1710 2700 4900 1574	960 1525 2700 3300 6425 1576	5.0 8.5 6.0 8.5 7.5	vertical
1399.99.0037		SWA-0825/360/5/30/DFRX30	Single port multi-band low profile cellular/Wifi antenna - embedded GNSS antenna - 40 mm height	790 1350 4900 1574	960 2170 6425 1576	5.0 5.0 8.0	vertical
MIMO							
1399.99.0130		SWA-0759/360/6/0/MIMO	2 port multi-band cellular/Wifi antenna - embedded GNSS antenna - 80 mm height	698 1350 2700 4900 1574	960 2700 3300 5935 1610	5.0 7.5 6.5 8.0	vertical
1399.99.0148		SWA-0759/360/6/0/MIMO	Same as type 1399.99.0130 - NFPA 130 compliant				
1399.99.0147		SWA-0759/360/6/0/MIMO	Same as type 1399.99.0130 - 2x Wifi ports				
1399.99.0057		SWA-0825/360/5/30/MIMO	2 port multi-band low profile cellular/Wifi antenna - embedded GNSS antenna - 40 mm height	790 1350 4900 1574	960 2700 6425 1576	5.0 5.0 7.5	vertical
MULTI							
1399.99.0133		SWA-0759/360/6/0/MULTI	Multi-port multi-band cellular/Wifi antenna - 8x Cellular/Wifi, 4x Wifi - embedded GNSS antenna - 80 mm height	694 1350 2700 3300 4900	960 2700 3300 4900 6425	5.0 6.0 6.0 6.0 7.0	vertical
1399.99.0153		SWA-0759/360/6/0/MULTI	Multi-port multi-band cellular/Wifi antenna - 4x Cellular/Wifi, 2x Wifi - embedded GNSS antenna - 80 mm height	694 1350 2700 3300 4900	960 2700 3300 4900 5975	5.0 6.0 6.0 6.0 7.0	vertical

SENCITY® Rail Excel

The SENCITY® Rail Excel antenna family provides a high-gain solution for trackside wireless communications on all types of trains.

SENCITY® Rail Excel antennas meet the special requirements of railway applications. They provide electrical protection against the impact of a contact with the overhead line.

Key features



- High-gain directional roof-top antenna with an extremely rugged mechanical design and 90 mm height
- Supports WiFi 2.4 or 5 GHz bands
- High-voltage protection (up to 27.5 kV)
- High current protection (up to 40 kA/100 ms)
- Works without metal ground plane

Target applications

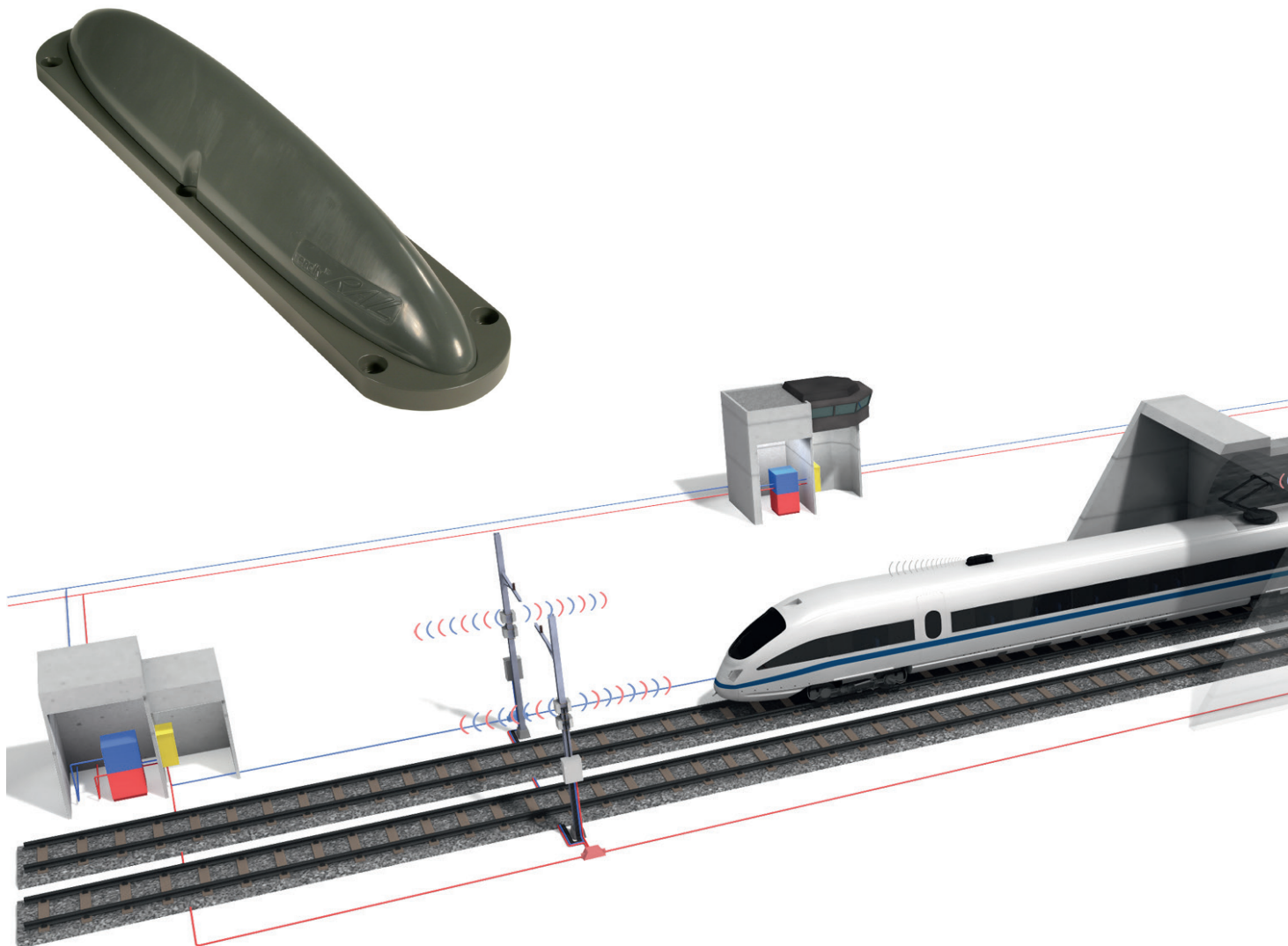
- CBTC (Communication Based Train Control)
- High-performance wireless backhaul links using a dedicated trackside antenna installation



SENCITY® Rail Excel antenna family

Type designation		Antenna family	Remarks	Freq. min. MHz	Freq. max. MHz	Gain dBi	Pol.
1324.17.0089		SPA-2400/40/15/10/V_3	directional	2400 2484 2550 2590 2630	2484 2550 2590 2630 2650	14.5 14.5 14.0 12.5 11.5	vertical
1356.17.0010		SPA-5600/45/12/10/V	directional	4900 5150	5150 5935	12.5 12.5	vertical

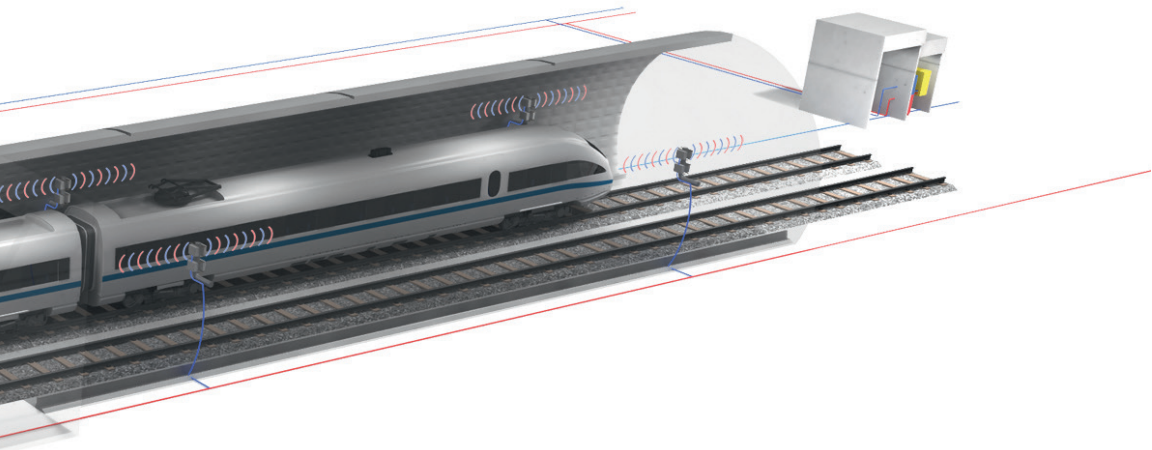

SENCITY® Road

The SENCITY® Road antenna family provides an all-in-one wireless communication solution for bus and metro vehicles with dedicated antenna ports for each application.

SENCITY® Road antennas meet the requirements of railway and automotive applications. The antenna can be customized in the order process (cable type/length, connector type, pigtail label inscriptions and more).

Key features

- Up to 4 antenna elements in one housing with single-hole mounting and 90 mm height*
- Multi-band support 380 MHz to 6 GHz*
- Cellular 2x2 and Wifi 3x3 MIMO
- Embedded GNSS antenna with integrated low-noise amplifier*
- ISO 16750, ECE-R118 compliant
- EN 50155, EN 45545-2 compliant
- High-voltage protection (up to 27.5 kV)*
- Works without metal ground plane*



Target applications

- Multi-band communications on buses, tramway and metro vehicles for CBTC (Communication Based Train Control) or ITCS (Intermodal Transport Control System)
- Internet-on-board or CCTV using MIMO in Wifi or cellular bands

*Depends on the model.



SENCITY® Road antenna family

Type designation		Antenna family	Remarks	Freq. min. MHz	Freq. max. MHz	Gain dBi	Pol.
SISO							
1399.99.0039		SWA-0860/360/5/10/DFRX30	Single ports for Cellular, Wifi, GNSS and stick antenna socket	698 1710 2700 4900 1574	960 2690 5935 1610	5 4 4 4 7	vertical
1399.99.0126		SWA-0860/360/5/10/DFRX30	Same as type 1399.99.0039 w/o stick antenna socket				
1399.99.0127		SWA-0460/360/5/10/DFRX30	Single ports for Tetra, Wifi, GNSS and stick antenna socket	410 1710 4900 1574	430 2690 5935 1610	4 6 7	vertical
MIMO							
1399.99.0128		SWA-2459/360/5/10/MIMO	3 port Wifi antenna	2400 4900	2690 5935	6 7	vertical
1399.99.0129		SWA-0727/360/4/10/MIMO	2 port multi-band cellular antenna – embedded GNSS antenna	698 1710 2400 1574	960 2170 2690 1610	3 4 4	vertical
1399.99.0119		SWA-0727/360/4/10/MIMO	Same as type 1399.99.0129 w/o GNSS antenna				

Accessories

Type designation	Remarks
9091.99.0246	FM stick antenna 88-108MHz
9091.99.0247	TETRA stick antenna 380-430MHz
9091.99.0254	TETRA stick antenna 410-430MHz
9091.99.0248	TETRA stick antenna 450-470MHz
9091.99.0250	Metal ground plane foil 0.6x0.6m

Additional antenna products

Vehicle outdoor

Antennas on the roof of a vehicle must allow multi-band operation. This approach eliminates the need to install more than one antenna and covers also future communication standards. Easy installation and maintenance-free products are the top priorities here.

In-carriage

For in-carriage applications, passenger safety is the main criterion. Besides offering high performance, our products are also fire retardant and use low toxicity materials (acc. to EN 45545-2 and NFPA 130).

Omni-directional as well as directional antennas are available in small form factors with different colors, connectors and mounting options.



Trackside (see page 186)

Trackside antennas are used for high data rate applications such as WiFi 2.4 GHz or WiMAX networks.

Special accessories are available for different applications, e.g. brackets, lightning protectors, DC/DC blocks, power splitters and RF cable assemblies.



Additional antenna products

Type designation		Antenna family	Remarks	Freq. min. MHz	Freq. max. MHz	Gain dBi	Pol.
Vehicle outdoor							
1399.17.0111 1399.17.0108		SWA-2459/360/7/20/V_2	- omni-directional - connector mounting - IP 68	2400 2500 3400 4900 5470	2500 2700 3700 5470 5935	6.0 6.0 7.0 8.0 8.0	vertical
In-carriage							
1324.17.0071		SOA-2400/360/4/20/V_2	omni-directional	2400	2500	4.0	vertical
1324.26.0049		SPA-2400/75/9/0/V_1	directional	2300	2500	8.5	vertical
1356.17.0043		SOA 5600/360/3/20/V_1	omni-directional	4900	5935	7.0	vertical
1356.26.0013		SPA-5600/60/10/0/V_1	directional	5150 5250	5250 5875	9.5 9.5	vertical
1399.17.0106		SWA-2459/360/7/20/V_1	omni-directional	2400 2500 3400 4900 5470	2500 2700 3700 5470 5935	6.0 6.0 7.0 8.0 8.0	vertical
1399.35.0002		SWA-2456/360/6/0/MIMO_2	omni-directional MIMO 3 x 3	2400 5150	2700 5935	4.0 4.0	vertical
1399.17.0240		SWA-2459/360/6/20/MIMO_4	omni-directional MIMO 4 x 4	2300 3400 4900	2700 3800 5975	1.5 2.0 3.5	vertical
1399.17.0210		SPA-2456/75/9/0/DF_1	directional dual band	2400 5150	2500 5875	9.0	vertical
1356.17.0076		SPA-5600/70/9/0/DS	directional MIMO 2 x 2	5150	5925	9.0	± 45°
1356.35.0003		SPA-5600/65/9/0/MIMO_1	directional MIMO 3 x 3	5150	5875	8.0	vertical and ± 45°



RF railway cables and connectors

HUBER+SUHNER is offering a wide range of RF coaxial cables which are developed for highest expectations. A carefully balanced range of flexible coaxial cables provides best performance where challenging requirements arise. Our high quality cables offer excellent electrical and mechanical characteristics and are used globally in high demanding railway applications.

Railway cable assemblies

Use our online configurator for fast and efficient configuration or calculation!

RF assembly configurator: <http://rfwebpcf.hubersuhner.com>

RF assembly calculator: <http://rfcablecalc.hubersuhner.com>

RF cable overview	164
Jumper cables	
RADOX_RF_316_D	167
RADOX_RF_58	168
RADOX_RF_142	169
RADOX_RF_400	170
Spuma_195-FR-01	171
Spuma_240-FR-01	172
SX_04172_B-60	173
Feeder cables	
RADOX_RF_213	175
RADOX_RF_214	176
Spuma_400-FR-01	177
Spuma_500-FR-01	178
S_10162_B-11	179
75 Ω coaxial cables	
RADOX_RF_179	181
RADOX_RF_59	182
Spuma_400-FR-75	183
RF connectors	184

RF cable overview

Jumper cables

Thin, flexible cables which can be used for narrow radius. Ideally suitable for highly reliable interconnect solution.

Cable type	Item no.	EN 45545	NFPA 130	Imp. Ω	Freq. GHz	Inner conductor	Dielectric*	Outer conductor	Jacket
RADOX_RF_316_D	85023719	X	X	50	6	strand-7	SPEX	braid/braid	RADOX®
RADOX_RF_58	85023726	X	X	50	2	strand-19	PEX	single braid	RADOX®
RADOX_RF_142	85023684	X	X	50	6	wire	SPEX	braid/braid	RADOX®
RADOX_RF_400	85023720	X	X	50	6	strand-19	SPEX	braid/braid	RADOX®
Spuma_195-FR-01	85021562	X	X	50	6	wire	SPE	tape/braid	LSFH
Spuma_240-FR-01	85021563	X	X	50	6	wire	SPE	tape/braid	LSFH
SX_04172_B-60	84026748	X	X	50	6	wire	SPEX	tape/braid	RADOX®

Feeder cables

Low loss cable for covering larger distance.

Cable type	Item no.	EN 45545	NFPA 130	Imp. Ω	Freq. GHz	Inner conductor	Dielectric*	Outer conductor	Jacket
RADOX_RF_213	85023730	X	X	50	2	strand-7	PEX	single braid	RADOX®
RADOX_RF_214	85023731	X	X	50	6	strand-7	PEX	braid/braid	RADOX®
Spuma_400-FR-01	84132035	X	X	50	6	wire	SPE	tape/braid	LSFH
Spuma_500-FR-01	85021564	X	X	50	6	wire	SPE	tape/braid	LSFH
S_10162_B-11	23002145	X	X	50	7.5	wire	SPE	tape/braid	LSFH

75 ohm cables

Specifically designed to carry video signals.

Cable type	Item no.	EN 45545	NFPA 130	Imp. Ω	Freq. GHz	Inner conductor	Dielectric*	Outer conductor	Jacket
RADOX_RF_179	85023705	X	X	75	1	strand-7	SPEX	single braid	RADOX®
RADOX_RF_59	85023729	X	X	75	1	strand-7	PEX	single braid	RADOX®
Spuma_400-FR-75	85022187	X	X	75	3	wire	SPE	tape/braid	LSFH

*Dielectric:

- SPE = foamed polyethylene
- PEX = cross-linked polyethylene
- SPEX = cross-linked foamed polyethylene

	Diameter mm	Temperature range °C	Attenuation at 1 GHz dB/m	Attenuation at 6 GHz dB/m	Screening effectiveness dB	Bending static mm	Bending repeated mm	Replacement for	Detailed information see page
	3.2	-40 to +105	0.89	2.65	> 70 dB (up to 6 GHz)	5	30	RG_316_D	167
	5.1	-40 to +105	0.56	-	> 40 dB (up to 2 GHz)	25	50	RG_58 C/U	168
	5.34	-40 to +105	0.51	1.75	> 75 dB (up to 5 GHz)	30	50	RG_142 B/U	169
	5.34	-40 to +105	0.54	1.84	> 70 dB (up to 6 GHz)	30	60	RG_400 B/U	170
	4.95	-40 to +85	0.39	1.00	> 90 dB (up to 6 GHz)	12	50		171
	6.15	-40 to +85	0.26	0.68	> 90 dB (up to 6 GHz)	19	63		172
	5.5	-40 to +105	0.28	0.84	> 80 dB (up to 2.2 GHz)	25	90		173

	Diameter mm	Temperature range °C	Attenuation at 1 GHz dB/m	Attenuation at 6 GHz dB/m	Screening effectiveness dB	Bending static mm	Bending repeated mm	Replacement for	Detailed information see page
	10.6	-40 to +105	0.26	-	> 41 dB (up to 2 GHz)	50	100	RG_213 /U	175
	11.1	-40 to +105	0.31	1.06	> 81 dB (up to 6 GHz)	50	110	RG_214 /U	176
	10.25	-40 to +85	0.13	0.35	> 90 dB (up to 6 GHz)	25	100		177
	12.78	-40 to +85	0.10	0.29	> 90 dB (up to 6 GHz)	31	127		178
	12.9	-40 to +85	0.10	0.28	> 90 dB (up to 7.5 GHz)	100	200		179

	Diameter mm	Temperature range °C	Attenuation at 1 GHz dB/m	Attenuation at 6 GHz dB/m	Screening effectiveness dB	Bending static mm	Bending repeated mm	Replacement for	Detailed information see page
	2.8	-40 to +105	0.90	-	> 40 dB (up to 1 GHz)	5	25	RG_179 B/U	181
	6.24	-40 to +105	0.49	-	> 40 dB (up to 1 GHz)	35	60	RG_59 C/U	182
	10.25	-40 to +85	0.13	-	> 90 dB (up to 3 GHz)	25	100		183

RF jumper cables

Applications

- Flexible jumper applications
- Inside or outside railway rolling stock
- Narrow radius installation
- Ideally for connecting antennas or components

Characteristics and specialties

- Railway approvals
- High flexible cables
- HUBER+SUHNER RADOX® jacket materials
- Flame retardant
- Low smoke and free of halogen

Attenuation

Typical values at +25 °C ambient temperature and sea level

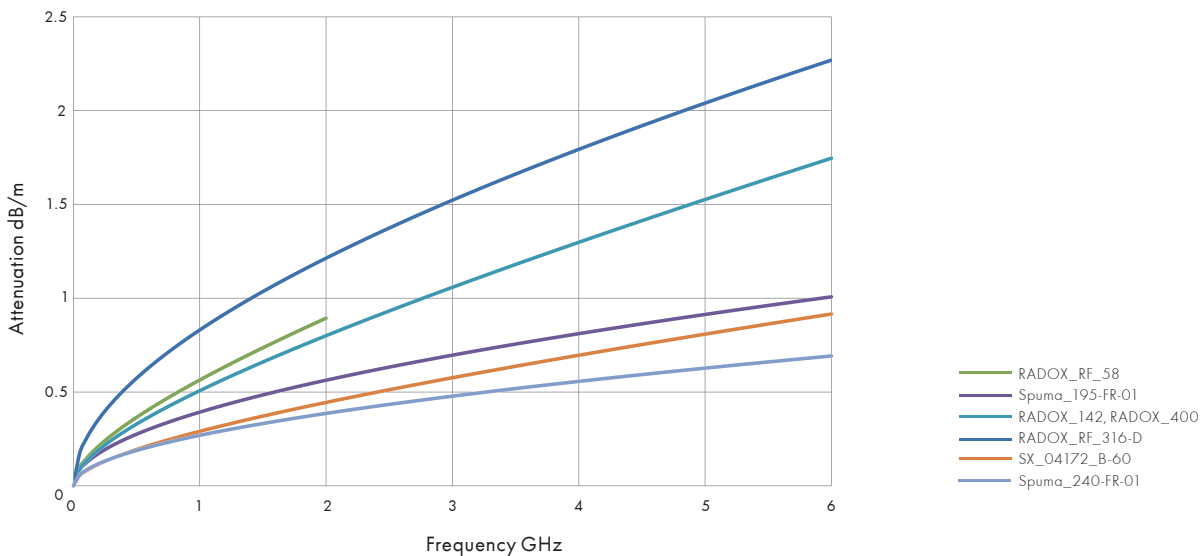

CW Power

Max. values at +40 °C ambient temperature and sea level

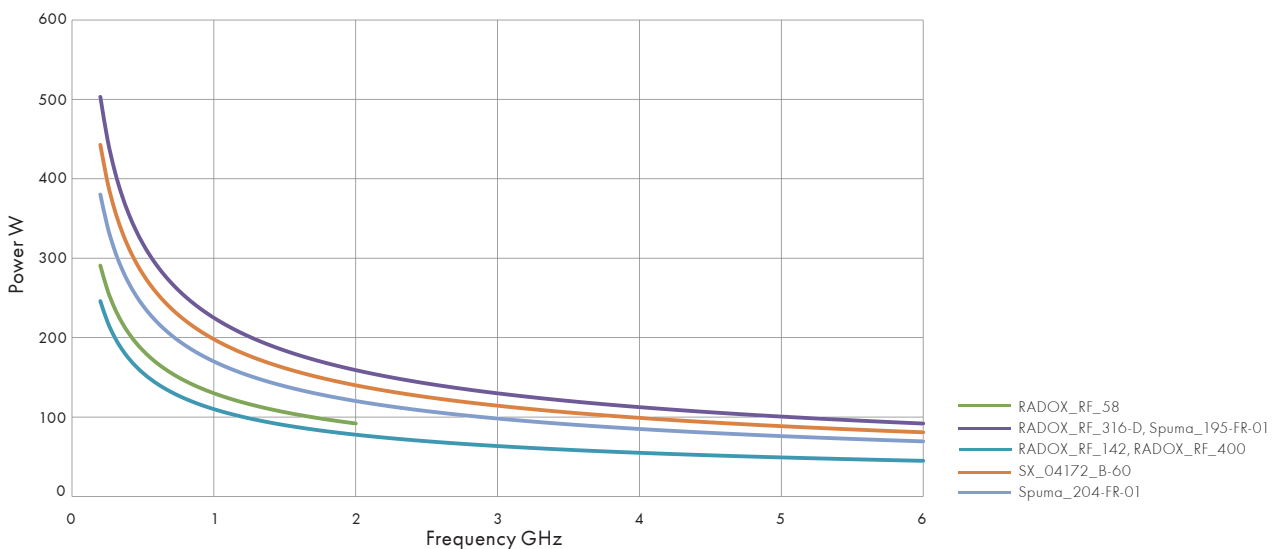

RADOX_RF_316_D coax cable

Item no. 85023719

Cable design



Composition of cable

	Description	Diameter
1 Centre conductor	steel, copper and silver plated, strand-07	0.54 mm
2 Dielectric	SPEX (cross-linked foamed polyethylene)	1.53 mm
3 Outer conductor	copper, silver plated, braid 96 %	1.99 mm
4 Outer conductor	copper, silver plated, braid 90 %	2.44 mm
5 Jacket	RADOX EM104, RAL 9005, black	3.2 mm ± 0.1

Electrical data

Impedance	50 Ω ± 2
Operating frequency	6 GHz
Capacitance	94.5 pF/m
Signal delay	4.72 ns/m
Velocity of propagation	70.1 %
Nominal attenuation	0.89 dB/m at 1 GHz
Max. operating voltage	≤ 1.5 kVrms (at sea level)
Min. screening effectiveness	≥ 70 dB up to 6 GHz

General cable data

Temperature range	-40 to +105 °C
Weight	2 kg/100 m
Min. bending radius static	5 mm
Min. bending radius repeated	30 mm

Standards

Railway standards	EN 45545 (HL3), NFPA-130
-------------------	--------------------------

Suitable connectors and cable groups

Connector series	N, QN, TNC, BNC, SMA, QMA
Cable group	U4

Please contact your nearest HUBER+SUHNER partner for specific connector information.

RADOX_RF_58 coax cable

Item no. 85023726

Cable design

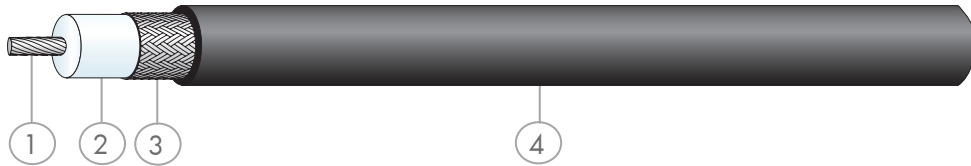

Composition of cable

	Description	Diameter
1 Centre conductor	copper, tin plated, strand-19	0.9 mm
2 Dielectric	PEX (cross-linked polyethylene)	2.95 mm
3 Outer conductor	copper, tin plated, braid 96 %	3.60 mm
4 Jacket	RADOX EM104, RAL 9005, black	5.1 mm ± 0.05

Electrical data

Impedance	50 Ω ± 2
Operating frequency	2 GHz
Capacitance	101 pF/m
Signal delay	5.05 ns/m
Velocity of propagation	66 %
Nominal attenuation	0.56 dB/m at 1 GHz
Max. operating voltage	≤ 2.5 kVrms (at sea level)
Min. screening effectiveness	≥ 40 dB up to 2 GHz

General cable data

Temperature range	-40 to +105 °C
Weight	4.13 kg/100 m
Min. bending radius static	25 mm
Min. bending radius repeated	50 mm

Standards

Railway standards	EN 45545 (HL3), NFPA-130
-------------------	--------------------------

Suitable connectors and cable groups

Connector series	N, QN, TNC, BNC, SMA, QMA
Cable group	U7

Please contact your nearest HUBER+SUHNER partner for specific connector information.

RADOX_RF_142 coax cable

Item no. 85023684

Cable design



Composition of cable

	Description	Diameter
1 Centre conductor	copper, silver plated, wire	0.95 mm
2 Dielectric	SPEX (cross-linked foamed polyethylene)	2.98 mm
3 Outer conductor	copper, silver plated, braid 97 %	3.58 mm
4 Outer conductor	copper, silver plated, braid 95 %	4.18 mm
5 Jacket	RADOX EM104, RAL 9005, black	5.34 mm ± 0.6

Electrical data

Impedance	50 Ω ± 2
Operating frequency	6 GHz
Capacitance	94.5 pF/m
Signal delay	4.7 ns/m
Velocity of propagation	70.9 %
Nominal attenuation	0.51 dB/m at 1 GHz
Max. operating voltage	≤ 2.5 kVrms (at sea level)
Min. screening effectiveness	≥ 75 dB up to 5 GHz

General cable data

Temperature range	-40 to +105 °C
Weight	5.7 kg/100 m
Min. bending radius static	30 mm
Min. bending radius repeated	50 mm

Standards

Railway standards	EN 45545 (HL3), NFPA-130
-------------------	--------------------------

Suitable connectors and cable groups

Connector series	N, QN, TNC, BNC, SMA
Cable group	U9

Please contact your nearest HUBER+SUHNER partner for specific connector information.

RADOX_RF_400 coax cable

Item no. 85023720

Cable design



Composition of cable

	Description	Diameter
1 Centre conductor	copper, silver plated, strand-19	1.00 mm
2 Dielectric	SPEX (cross-linked foamed polyethylene)	2.98 mm
3 Outer conductor	copper, silver plated, braid 96 %	3.61 mm
4 Outer conductor	copper, silver plated, braid, 94 %	4.2 mm
5 Jacket	RADOX EM104, RAL 9005, black	5.34 mm ± 0.06

Electrical data

Impedance	50 Ω ± 2
Operating frequency	6 GHz
Capacitance	94.5 pF/m
Signal delay	4.74 ns/m
Velocity of propagation	70.3 %
Nominal attenuation	0.54 dB/m at 1 GHz
Max. operating voltage	≤ 2.5 kVrms (at sea level)
Min. screening effectiveness	≥ 70 dB up to 6 GHz

General cable data

Temperature range	-40 to +105 °C
Weight	5.6 kg/100 m
Min. bending radius static	30 mm
Min. bending radius repeated	60 mm

Standards

Railway standards	EN 45545 (HL3), NFPA-130
-------------------	--------------------------

Suitable connectors and cable groups

Connector series	N, QN, TNC, BNC, SMA
Cable group	U41

Please contact your nearest HUBER+SUHNER partner for specific connector information.

Spuma_195-FR-01 coax cable

Item no. 85021562

Cable design



Composition of cable

	Description	Diameter
1 Centre conductor	copper, wire	0.94 mm
2 Dielectric	SPE (foamed polyethylene)	2.83 mm
3 Outer conductor	aluminium, PES, longitudinal foil, 100 %	2.95 mm
4 Outer conductor	copper, tin plated, braid, 92 %	3.52 mm
5 Jacket	LSFH (modified polyethylene), RAL 9005, black	4.98 mm ± 0.1

Electrical data

Impedance	50 Ω ± 2
Operating frequency	6 GHz
Capacitance	90.8 pF/m
Signal delay	4.54 ns/m
Velocity of propagation	76.1 %
Nominal attenuation	0.39 dB/m at 1 GHz
Max. operating voltage	≤ 0.5 kVrms (at sea level)
Min. screening effectiveness	≥ 90 dB up to 6 GHz

General cable data

Temperature range	-40 to +85 °C
Weight	3.97 kg/100 m
Min. bending radius static	10 mm
Min. bending radius repeated	40 mm

Standards

Railway standards	EN 45545 (HL3), NFPA 130
-------------------	--------------------------

Suitable connectors and cable groups

Connector series	N, TNC, SMA
Cable group	X27

Please contact your nearest HUBER+SUHNER partner for specific connector information.

Spuma_240-FR-01 coax cable

Item no. 85021563

Cable design

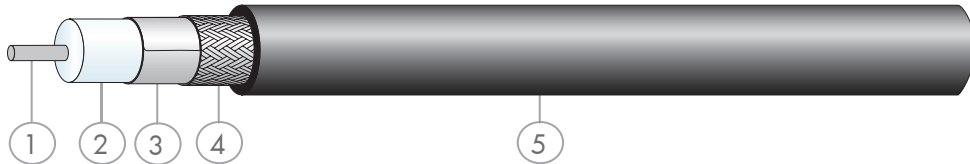

Composition of cable

	Description	Diameter
1 Centre conductor	copper, wire	1.42 mm
2 Dielectric	SPE (foamed polyethylene)	3.82 mm
3 Outer conductor	aluminium, PES, longitudinal foil, 100 %	3.94 mm
4 Outer conductor	copper, tin plated, braid, 94 %	4.52 mm
5 Jacket	LSFH (modified polyethylene), RAL 9005, black	6.17 mm ± 0.1

Electrical data

Impedance	50 Ω ± 2
Operating frequency	6 GHz
Capacitance	78.9 pF/m
Signal delay	4.05 ns/m
Velocity of propagation	82.6 %
Nominal attenuation	0.27 dB/m at 1 GHz
Max. operating voltage	≤ 0.9 kVrms (at sea level)
Min. screening effectiveness	≥ 90 dB up to 6 GHz

General cable data

Temperature range	-40 to +85 °C
Weight	6.1 kg/100 m
Min. bending radius static	14 mm
Min. bending radius repeated	53 mm

Standards

Railway standards	EN 45545 (HL3), NFPA 130
-------------------	--------------------------

Suitable connectors and cable groups

Connector series	N, QN, TNC, BNC, SMA, QMA
Cable group	X28

Please contact your nearest HUBER+SUHNER partner for specific connector information.

SX_04172_B-60 coax cable

Item no. 84026748

Cable design

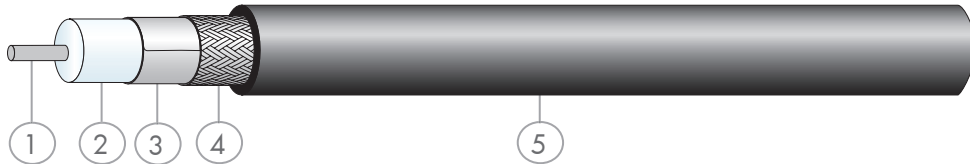

Composition of cable

	Description	Diameter
1 Centre conductor	copper, silver plated, wire	1.4 mm
2 Dielectric	SPEX (cross-linked foamed polyethylene)	3.83 mm
3 Outer conductor	aluminium, PES, longitudinal foil	4.2 mm
4 Outer conductor	copper, tin plated, braid 86 %	4.6 mm
5 Jacket	RADOX®, RAL 9005, black	5.5 mm ± 0.1

Electrical data

Impedance	50 Ω ± 2
Operating frequency	6 GHz
Capacitance	80.3 pF/m
Signal delay	4.01 ns/m
Velocity of propagation	83 %
Nominal attenuation	0.28 dB/m at 1 GHz
Max. operating voltage	≤ 0.7 kVrms (at sea level)
Min. screening effectiveness	≥ 80 dB up to 2.2 GHz

General cable data

Temperature range	-40 to +105 °C
Weight	4.78 kg/100 m
Min. bending radius static	25 mm
Min. bending radius repeated	90 mm

Standards

Railway standards	EN 45545 (HL3), NFPA-130
-------------------	--------------------------

Suitable connectors and cable groups

Connector series	N, QN, TNC, BNC, SMA, QMA
Cable group	X9

Please contact your nearest HUBER+SUHNER partner for specific connector information.

RF feeder cables

Applications

- Fixed installations
- Inside or outside railway rolling stock
- Long distance RF signal transmission

Characteristics and specialties

- Railway approvals
- Very low loss
- HUBER+SUHNER RADOX® or LSFH jacket materials
- Flame retardant
- Low smoke and free of halogen

Attenuation

Typical values at +25 °C ambient temperature and sea level

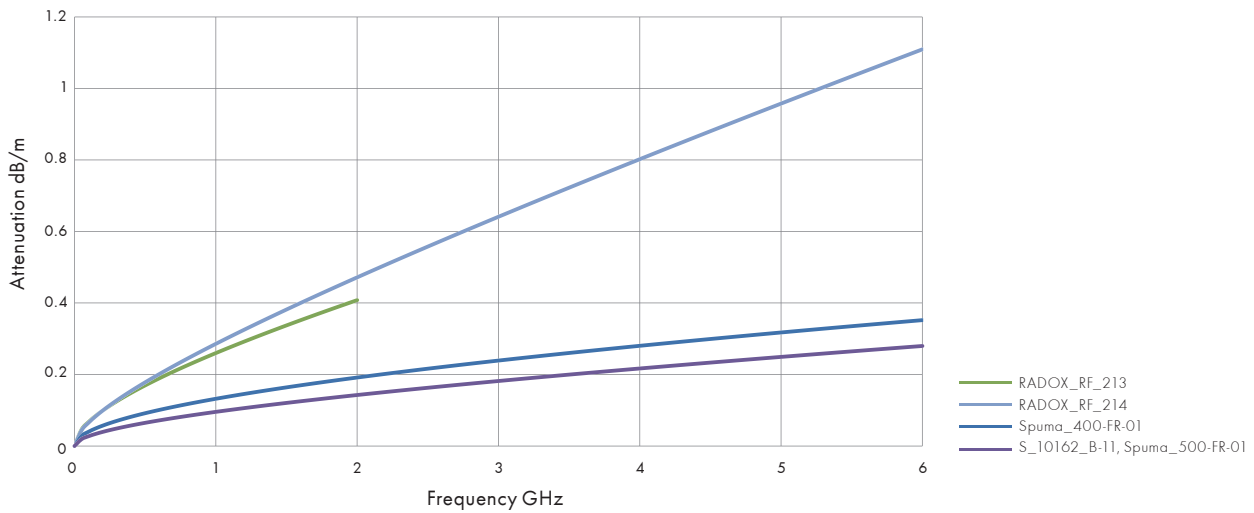

CW Power

Max. values at +40 °C ambient temperature and sea level

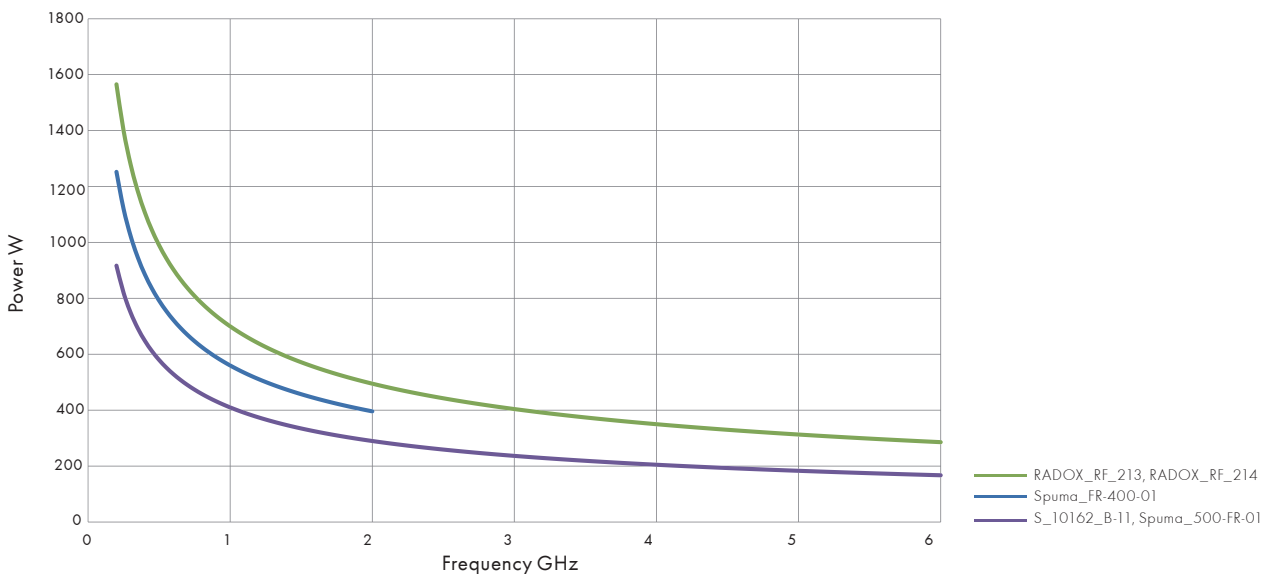

RADOX_RF_213 coax cable

Item no. 85023730

Cable design

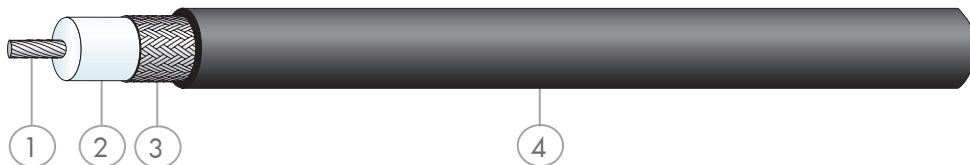

Composition of cable

	Description	Diameter
1 Centre conductor	copper, strand-07	2.25 mm
2 Dielectric	PEX (cross-linked polyethylene)	7.25 mm
3 Outer conductor	copper, silver plated, braid 95 %	8.09 mm
4 Jacket	RADOX EM104, RAL 9005, black	10.6 mm \pm 0.1

Electrical data

Impedance	50 Ω \pm 2
Operating frequency	2 GHz
Capacitance	101 pF/m
Signal delay	5.03 ns/m
Velocity of propagation	66 %
Nominal attenuation	0.26 dB/m at 1 GHz
Max. operating voltage	\leq 5 kVrms (at sea level)
Min. screening effectiveness	\geq 41 dB up to 2 GHz

General cable data

Temperature range	-40 to +105 °C
Weight	16.8 kg/100 m
Min. bending radius static	50 mm
Min. bending radius repeated	100 mm

Standards

Railway standards	EN 45545 (HL3), NFPA-130
-------------------	--------------------------

Suitable connectors and cable groups

Connector series	N, QN, TNC, BNC
Cable group	U42

Please contact your nearest HUBER+SUHNER partner for specific connector information.

RADOX_RF_214 coax cable

Item no. 85023731

Cable design

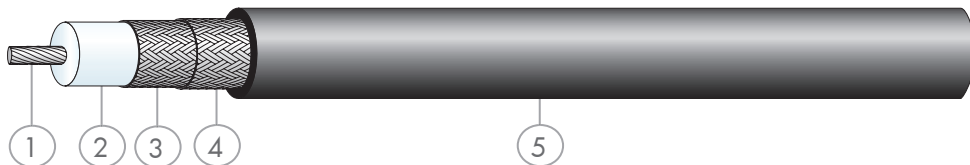

Composition of cable

	Description	Diameter
1 Centre conductor	copper, silver plated, strand-07	2.25 mm
2 Dielectric	PEX (cross-linked polyethylene)	7.28 mm
3 Outer conductor	copper, silver plated, braid 93 %	8.00 mm
4 Outer conductor	copper, silver plated, braid 95 %	8.6 mm
5 Jacket	RADOX EM104, RAL 9005, black	11.1 mm ± 0.1

Electrical data

Impedance	50 Ω ± 2
Operating frequency	6 GHz
Capacitance	101.4 pF/m
Signal delay	5.03 ns/m
Velocity of propagation	66 %
Nominal attenuation	0.31 dB/m at 1 GHz
Max. operating voltage	≤ 5 kVrms (at sea level)
Min. screening effectiveness	≥ 81 dB up to 6 GHz

General cable data

Temperature range	-40 to +105 °C
Weight	20.3 kg/100 m
Min. bending radius static	50 mm
Min. bending radius repeated	110 mm

Standards

Railway standards	EN 45545 (HL3), NFPA-130
-------------------	--------------------------

Suitable connectors and cable groups

Connector series	N, QN, TNC, BNC
Cable group	U43

Please contact your nearest HUBER+SUHNER partner for specific connector information.

Spuma_400-FR-01 coax cable

Item no. 84132035

Cable design

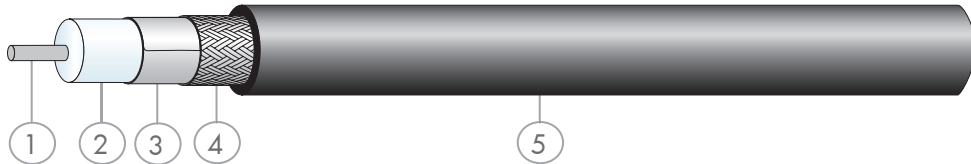

Composition of cable

	Description	Diameter
1 Centre conductor	aluminium/copper, wire	2.74 mm
2 Dielectric	SPE (foamed polyethylene)	7.24 mm
3 Outer conductor	aluminium, PES, longitudinal foil, 100 %	7.40 mm
4 Outer conductor	copper, tin plated, braid 78 %	8.15 mm
5 Jacket	LSFH (modified polyethylene), RAL 9005, black	10.25 mm ± 0.1

Electrical data

Impedance	50 Ω ± 2
Operating frequency	6 GHz
Capacitance	78 pF/m
Signal delay	3.9 ns/m
Velocity of propagation	85 %
Nominal attenuation	0.13 dB/m at 1 GHz
Max. operating voltage	≤ 1.6 kVrms (at sea level)
Min. screening effectiveness	≥ 90 dB up to 6 GHz

General cable data

Temperature range	-40 to +85 °C
Weight	11.5 kg/100 m
Min. bending radius static	25 mm
Min. bending radius repeated	100 mm

Standards

Railway standards	EN 45545 (HL3), NFPA 130
-------------------	--------------------------

Suitable connectors and cable groups

Connector series	N, QN, TNC
Cable group	U30

Please contact your nearest HUBER+SUHNER partner for specific connector information.

Spuma_500-FR-01 coax cable

Item no. 85021564

Cable design

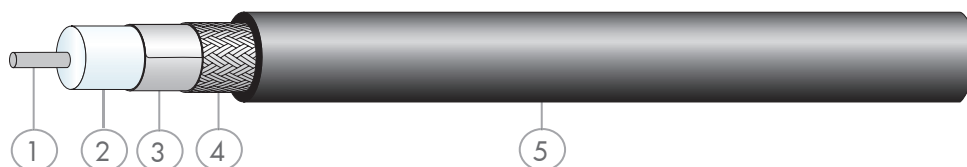

Composition of cable

	Description	Diameter
1 Centre conductor	aluminium/copper, wire	3.58 mm
2 Dielectric	SPE (foamed polyethylene)	9.43 mm
3 Outer conductor	aluminium, PES, longitudinal foil, 100 %	9.55 mm
4 Outer conductor	copper, tin plated, braid, 90 %	10.36 mm
5 Jacket	LSFH (modified polyethylene), RAL 9005, black	12.78 mm ± 0.1

Electrical data

Impedance	50 Ω ± 2
Operating frequency	6 GHz
Capacitance	77.4 pF/m
Signal delay	3.87 ns/m
Velocity of propagation	86 %
Nominal attenuation	0.11 dB/m at 1 GHz
Max. operating voltage	≤ 1.2 kVrms (at sea level)
Min. screening effectiveness	≥ 90 dB up to 6 GHz

General cable data

Temperature range	-40 to +85 °C
Weight	17.8 kg/100 m
Min. bending radius static	34 mm
Min. bending radius repeated	130 mm

Standards

Railway standards	EN 45545 (HL3), NFPA-130
-------------------	--------------------------

Suitable connectors and cable groups

Connector series	N
Cable group	X31

Please contact your nearest HUBER+SUHNER partner for specific connector information.

S_10162_B-11 coax cable

Item no. 23002145

Cable design

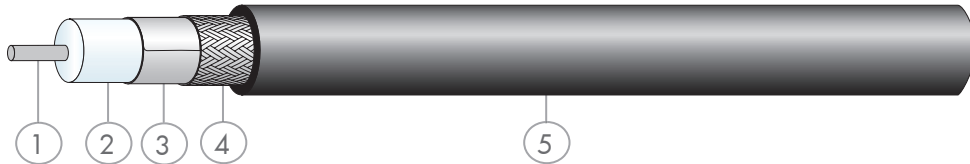

Composition of cable

	Description	Diameter
1 Centre conductor	copper clad aluminium, wire	3.8 mm
2 Dielectric	SPE (foamed polyethylene)	9.9 mm
3 Outer conductor	copper, longitudinal foil 100 %	10.0 mm
4 Outer conductor	copper, braid 80 %	10.8 mm
5 Jacket	LSFH (modified polyethylene), RAL 9005, black	12.9 mm ± 0.2

Electrical data

Impedance	50 Ω ± 2
Operating frequency	7.5 GHz
Capacitance	77 pF/m
Signal delay	3.85 ns/m
Velocity of propagation	87 %
Nominal attenuation	0.10 dB/m at 1 GHz
Max. operating voltage	≤ 1.7 kVrms (at sea level)
Min. screening effectiveness	≥ 90 dB up to 7.5 GHz

General cable data

Temperature range	-40 to +85 °C
Weight	15.0 kg/100 m
Min. bending radius static	100 mm
Min. bending radius repeated	200 mm

Standards

Railway standards	EN 45545 (HL3), NFPA-130
-------------------	--------------------------

Suitable connectors and cable groups

Connector series	N, TNC
Cable group	S39

Please contact your nearest HUBER+SUHNER partner for specific connector information.

75 Ω coaxial cables

Applications

- CCTV applications
- Passenger information or infotainment solutions
- Any video signal transmission

Characteristics and specialties

- EN 45545 compliant (HL3)
- HUBER+SUHNER RADOX® and LSFH jacket materials
- Flame retardant
- Low smoke and free of halogen

Attenuation

Typical values at +25 °C ambient temperature and sea level

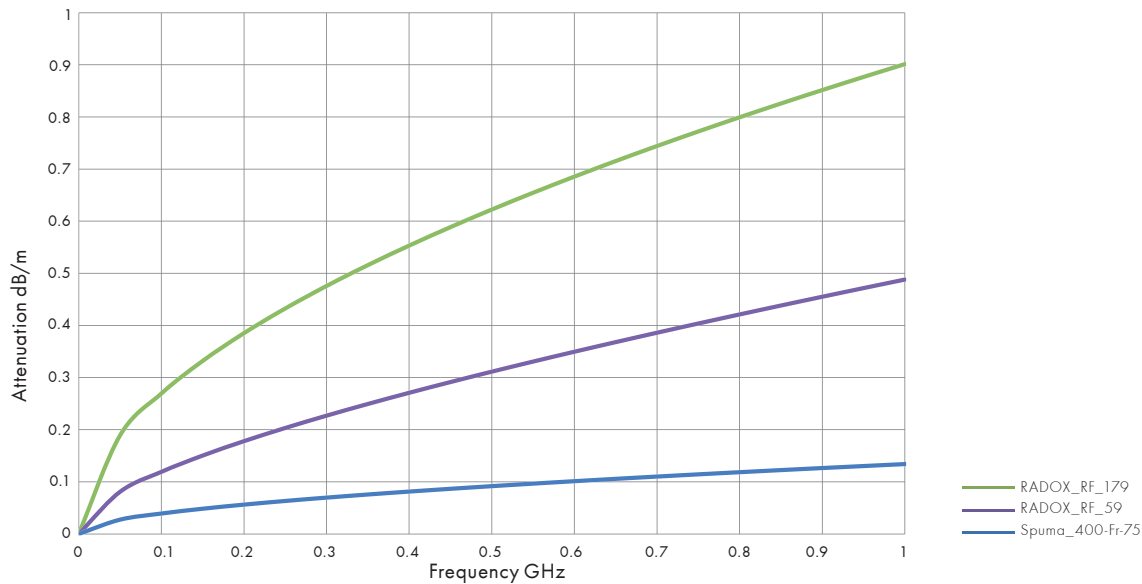

CW Power

Max. values at +40 °C ambient temperature and sea level

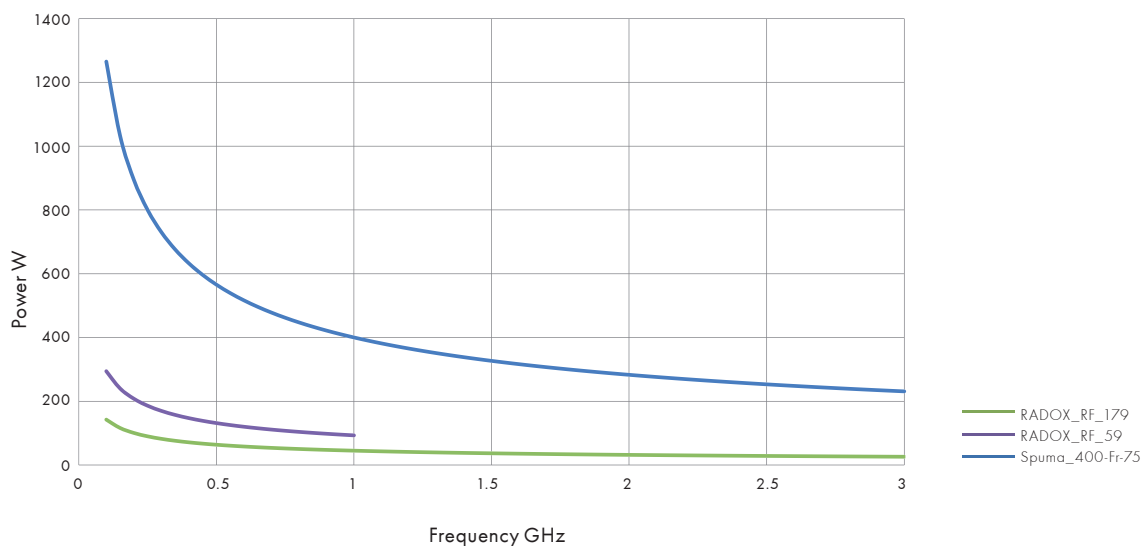

RADOX_RF_179 coax cable

Item no. 85023705

Cable design

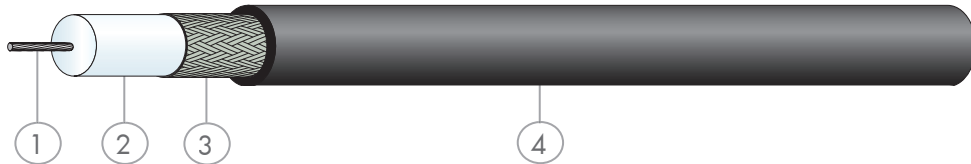

Composition of cable

	Description	Diameter
1 Centre conductor	steel, copper and silver plated, strand-07	0.305 mm
2 Dielectric	SPEX (cross-linked foamed polyethylene)	1.55 mm
3 Outer conductor	copper, silver plated, braid 94 %	2 mm
4 Jacket	RADOX EM104, RAL 9005, black	2.8 mm ± 0.1

Electrical data

Impedance	75 Ω ± 3
Operating frequency	3 GHz
Capacitance	63 pF/m
Signal delay	4.78 ns/m
Velocity of propagation	69.7 %
Nominal attenuation	0.90 dB/m at 1 GHz
Max. operating voltage	≤ 1 kVrms (at sea level)
Min. screening effectiveness	≥ 40 dB up to 1 GHz

General cable data

Temperature range	-40 to +105 °C
Weight	1.3 kg/100 m
Min. bending radius static	5 mm
Min. bending radius repeated	25 mm

Standards

Railway standards	EN 45545 (HL3), NFPA-130
-------------------	--------------------------

Suitable connectors and cable groups

Connector series	TNC, BNC, MCX
Cable group	U5

Please contact your nearest HUBER+SUHNER partner for specific connector information.

RADOX_RF_59 coax cable

Item no. 85023729

Cable design

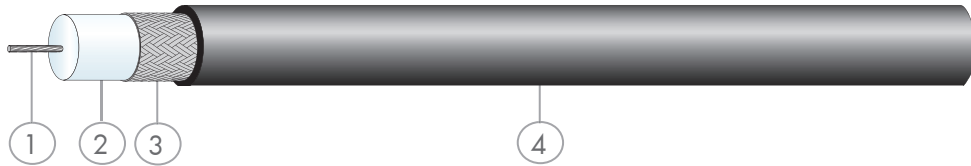

Composition of cable

	Description	Diameter
1 Centre conductor	copper, tin plated, strand-07	0.66 mm
2 Dielectric	PEX (cross-linked polyethylene)	3.83 mm
3 Outer conductor	copper, tin plated, braid 94 %	4.42 mm
4 Jacket	RADOX EM104, RAL 9005, black	6.24 mm ± 0.06

Electrical data

Impedance	75 Ω ± 3
Operating frequency	1 GHz
Capacitance	68 pF/m
Signal delay	5.05 ns/m
Velocity of propagation	66.1 %
Nominal attenuation	0.49 dB/m at 1 GHz
Max. operating voltage	≤ 3 kVrms (at sea level)
Min. screening effectiveness	≥ 40 dB up to 1 GHz

General cable data

Temperature range	-40 to +105 °C
Weight	5.5 kg/100 m
Min. bending radius static	35 mm
Min. bending radius repeated	60 mm

Standards

Railway standards	EN 45545 (HL3), NFPA-130
-------------------	--------------------------

Suitable connectors and cable groups

Connector series	N, TNC, BNC
Cable group	U16

Please contact your nearest HUBER+SUHNER partner for specific connector information.

Spuma_400-FR-75 coax cable

Item no. 85022187

Cable design

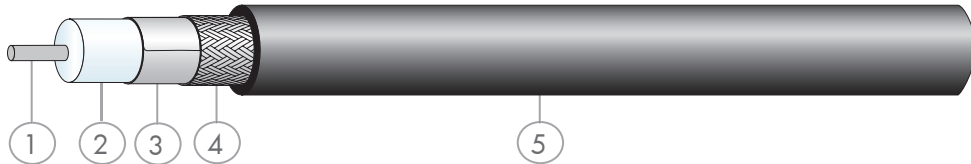

Composition of cable

	Description	Diameter
1 Centre conductor	copper, wire	1.65 mm
2 Dielectric	SPE (foamed polyethylene)	7.24 mm
3 Outer conductor	aluminium, PES, longitudinal foil, 100 %	7.40 mm
4 Outer conductor	copper, tin plated, braid 78 %	8.15 mm
5 Jacket	LSFH (modified polyethylene), RAL 9005, black	10.25 mm ± 0.1

Electrical data

Impedance	75 Ω ± 3
Operating frequency	3 GHz
Capacitance	53 pF/m
Signal delay	3.9 ns/m
Velocity of propagation	84 %
Nominal attenuation	0.13 dB/m at 1 GHz
Max. operating voltage	≤ 1.6 kVrms (at sea level)
Min. screening effectiveness	≥ 90 dB up to 3 GHz

General cable data

Temperature range	-40 to +85 °C
Weight	12 kg/100 m
Min. bending radius static	25 mm
Min. bending radius repeated	100 mm

Standards

Railway standards	EN 45545 (HL3), NFPA-130
-------------------	--------------------------

Suitable connectors and cable groups

Connector series	BNC
Cable group	X33

Please contact your nearest HUBER+SUHNER partner for specific connector information.

RF connectors

HUBER+SUHNER is one of the leading RF connector designer and manufacturer with a world wide sales and distribution network.



Series N connectors

- Available with 50 Ω and 75 Ω impedance
- Frequency range: DC - 18 GHz (50 Ω)
- Screw type coupling mechanism

Interface dimensions conformable to the standards:

- International: IEC 60169-16
- Europe: CECC 22210
- USA: MIL-STD-348A/304



Series SMA connectors

- Precision connectors
- 50 Ω impedance
- Frequency range: DC - 18 GHz
- Screw type coupling mechanism

Interface dimensions conformable to the standards:

- International: IEC 60169-15
- Europe: CECC 22110
- USA: MIL-STD-348A/310



Series BNC connectors

- Available with 50 Ω and 75 Ω impedance
- Frequency range DC - 4 GHz (50 Ω)
- Two stud bayonet coupling mechanism

Interface dimensions conformable to the standards:

- International: IEC 60169-8
- Europe: CECC 22120
- USA: MIL-STD-348A/301

RF connectors



Series TNC connectors

- Available with 50 Ω and 75 Ω impedance
- Frequency range: DC - 11 GHz (50 Ω)
- Screw type coupling mechanism

Interface dimensions conformable to the standards:

- International: IEC 60169-17
- Europe: CECC 22200
- USA: MIL-STD-348A/313



Series QMA connectors

- 50 Ω impedance
- Frequency range: DC - 18 GHz
- Snap-lock coupling mechanism
- Cycle time improvement for making connections (10 times faster to mount than threaded connectors)
- No torque required
- High packing density
- Free rotating connection when mated
- Eliminates loosening problems associated with threaded connectors
- Conform to QLF[®] standard



Series QN connectors

- 50 Ω impedance
- Frequency range: DC - 11 GHz
- Snap-lock coupling mechanism
- Cycle time improvement for making connections (10 times faster to mount than threaded connectors)
- No torque required
- High packing density
- Free rotating connection when mated
- Eliminates loosening problems associated with threaded connectors
- Conform to QLF[®] standard

RF trackside products

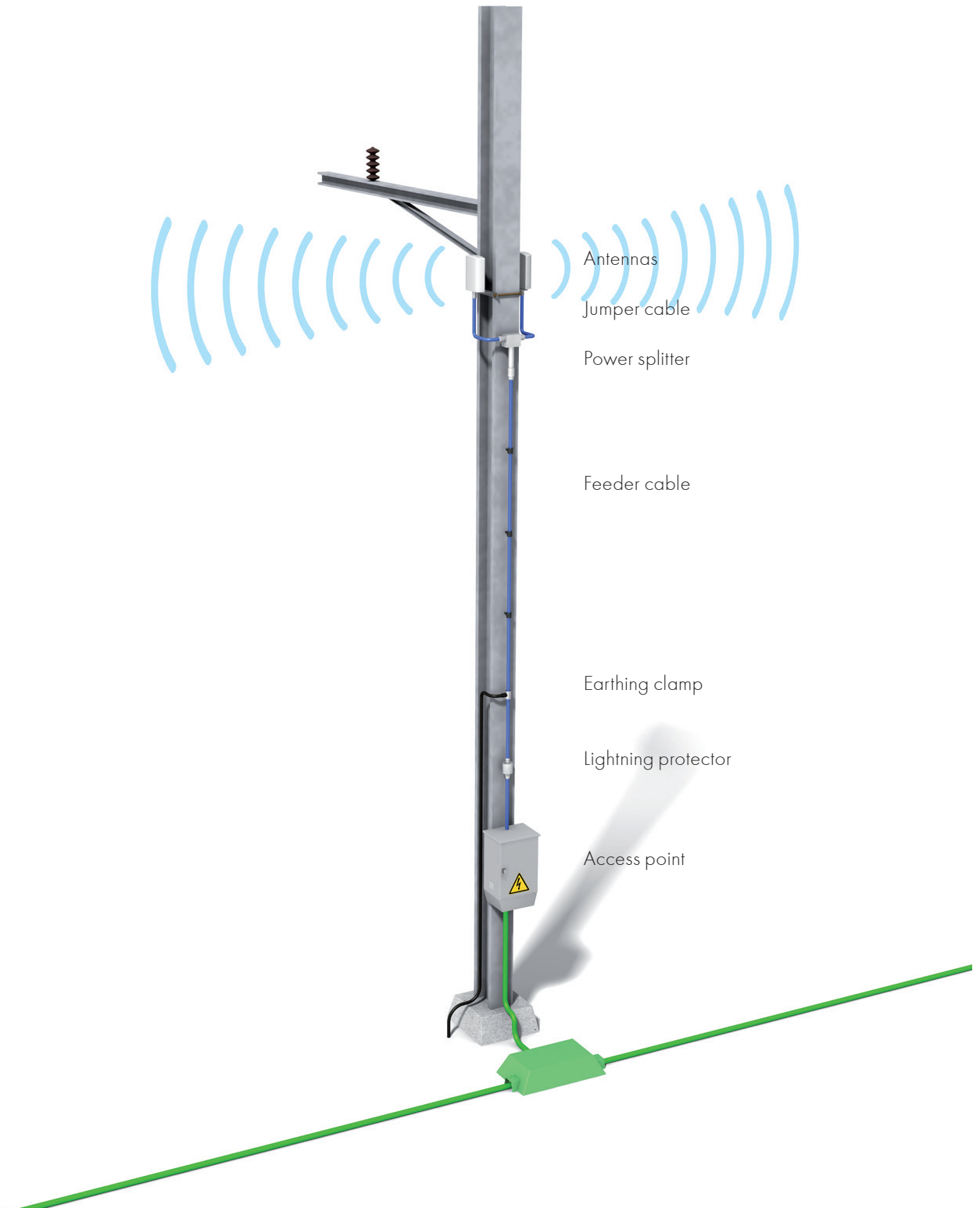

HUBER+SUHNER supplies antennas, lightning protection components and DC blocks specially designed for installation along railway lines, in tunnels and at railway stations and depots. Special accessories are available for a variety of applications, e.g. mounting brackets, lightning protection components, DC blocks, RF power dividers and pre-assembled RF cables. HUBER+SUHNER products for railway applications are generally characterised by their robust design, reliability and excellent RF properties. They are especially suitable for CBTC applications (Communication Based Train Control).



RF trackside products

Trackside antennas

Trackside antennas are used for high data rate or train control applications such as CCTV or CBTC using Wifi 2.4/5 GHz, LTE or WiMAX technology.

	Antenna family	Type designation	Dimensions mm	Frequency range MHz	Gain dBi	Polarisation
	SPOT-S	1324.17.0098	100 × 81 × 36	2400 - 2485	8.5	vertical
		1351.17.0001	100 × 81 × 36	4900 - 5350	13.5	vertical
		1356.17.0077	100 × 81 × 36	5150 - 5975	14	vertical
		1399.19.0221	100 × 81 × 36	2400 - 2700 5150 - 5975	9	vertical
		1324.17.0099	100 × 81 × 36	2400 - 2484	8	± 45°
		1356.17.0076	100 × 81 × 36	5150 - 5935	9	± 45°
		1356.35.0003	100 × 81 × 36	5150 - 5935	8	vertical, ± 45°
	SPOT-M	1324.17.0105	80 × 80 × 390	2400 - 2485	14	vertical
	SPOT-M, SPOT-L	1324.17.0051	190 × 190 × 30	2300 - 2700	14.5	vertical
		1324.17.0112	305 × 305 × 25	2300 - 2700	17	vertical
		1356.17.0024	190 × 190 × 30	5150 - 5875	18	vertical
		1354.17.0001	305 × 305 × 15	4900 - 5875	23	vertical
		1324.17.0106	305 × 305 × 15	2300 - 2700	18	± 45°
		1356.17.0023	190 × 190 × 30	5150 - 5875	19	vertical/horizontal
		1356.17.0090	305 × 305 × 15	4900 - 6100	18	vertical, ± 45°
		1355.17.0001	305 × 305 × 15	4900 - 6100	23	vertical/horizontal

RF trackside products

Lightning protection components

The requirements during open-air installation on railway lines are similar to those for the installation of mobile communication base stations. Series 3407 components include DC decoupling of the protected connection. The WLAN broadband lightning protection is designed specially for WLAN 2.4/5 GHz.



Type	Description	Frequency range MHz	IP rating	Connector
3400.17.0410*	quarter-wave stub protector	2000 - 6000	68	N(m)/N(f)
3400.17.0426**	quarter-wave stub protector	2000 - 6000	68	N(f)/N(f)
3400.17.0428**	quarter-wave stub protector	2000 - 6000	68	N(m)/N(f)
3403.17.0060**	GPS protector	800 - 2500	67	N(f)/N(f)
3403.17.0063**	GPS protector	800 - 2500	67	N(f)/N(m)
3414.99.0022**	data line protector (cat. 6)	DC - 250	68	RJ45/RJ45

* Brass (SUCOPLATE®)

** Aluminium

Please contact your nearest HUBER+SUHNER partner for specific information on earthing clamps.

Please find further lightning protection components as well as full details in our catalogue «Lightning Protection» <http://ipaper.ipapercms.dk/hubersuhner/technologies/radiofrequency/lightningprotection>.

DC and DC/DC blocks

The HUBER+SUHNER DC block product line includes DC blocks (inner conductor disconnected) and DC-DC blocks (inner and outer conductor disconnected) for galvanic isolation up to 15 kV. They block high-amplitude and low frequency surge voltages e.g. occurring during regular electric railway operation along railway lines. They provide sufficient safety even in the worst case scenario if the overhead high voltage lines fall to the ground.

Type	Description	Frequency range MHz	Blocking voltage	Connector
9077.17.0015 9077.17.0016	broadband high voltage DC block	140 - 2700	4 kV	N(f)/N(f) N(m)/N(f)
9077.17.0030 9077.17.0031	broadband high voltage DC/DC block	160 - 3000	4 kV	N(m)/N(f) N(f)/N(f)
9077.17.0006 9077.17.0022	broadband high voltage DC/DC block	180 - 3000	15 kV	N(m)/N(f) N(f)/N(f)
9077.17.0035	broadband high voltage DC/DC block	160 - 3000 4900 - 6000	4 kV	N(m)/N(f)

Please find further lightning protection components as well as full details in our catalogue «Lightning Protection» <http://ipaper.ipapercms.dk/hubersuhner/Technologies/Radiofrequency/Lightingprotection> in EMP protectors and the individual data sheets.

RF trackside products

High frequency power splitter

The symmetrical RF power dividers are used for diversity transmission and for bidirectional track illumination. They feature low insertion loss and high adaptability.



Type	Description	Frequency range MHz	IP Rating	Connector
5504.17.0005	broadband power splitter	2000 - 6000	65	N(f)/N(f)

Please find further products as well as full details in our catalogue «RF and Microwave-Components» <http://ipaper.ipapercms.dk/hubersuhner/technologies/radiofrequency/RFMWcomponentsEN/> and the individual data sheets.

Cable assemblies

In addition to the special railway cable range, the broad range of industrial cables and connectors from HUBER+SUHNER is available, depending on the specific requirements placed on the installation.

Use our online configurator under <http://rfwebpcf.hubersuhner.com> to configure your cable assemblies quickly and efficiently!



Type	Cable	N interface plug male	N interface jack female	Attenuation at 6 GHz dB/m	Outer diameter mm	Min. bending radius (static) mm
Feeder cable	Spuma_400	11_N-50-7-69	21_N-50-7-32	0.35	10.25	25
Jumper cable	S_04162_B	11_N-50-4-11	21_N-50-4-6	0.77	5.5	25
Feeder cable Tunnel applications*	Spuma_400-FR-01	11_N-50-7-69	21_N-50-7-32	0.35	10.25	25
	S_10162_B-11	11_N-50-10-5	21_N-50-10-1	0.28	12.9	100
Jumper cable Tunnel applications*	SX_04172_B-60	11_N-50-4-11	21_N-50-4-6	0.92	5.5	25
	RADOX_RF_400	11_N-50-3-59	21_N-50-3-20	1.65	5.3	10

* Cables for tunnel applications with enhanced fire performance acc. to EN 45545-2 or DIN 5510-2.

RF components

Please find more RF components such as attenuators and terminations in our catalogue «RF and Microwave Components» <http://ipaper.ipapercms.dk/hubersuhner/technologies/radiofrequency/RFMWcomponentsEN/>.

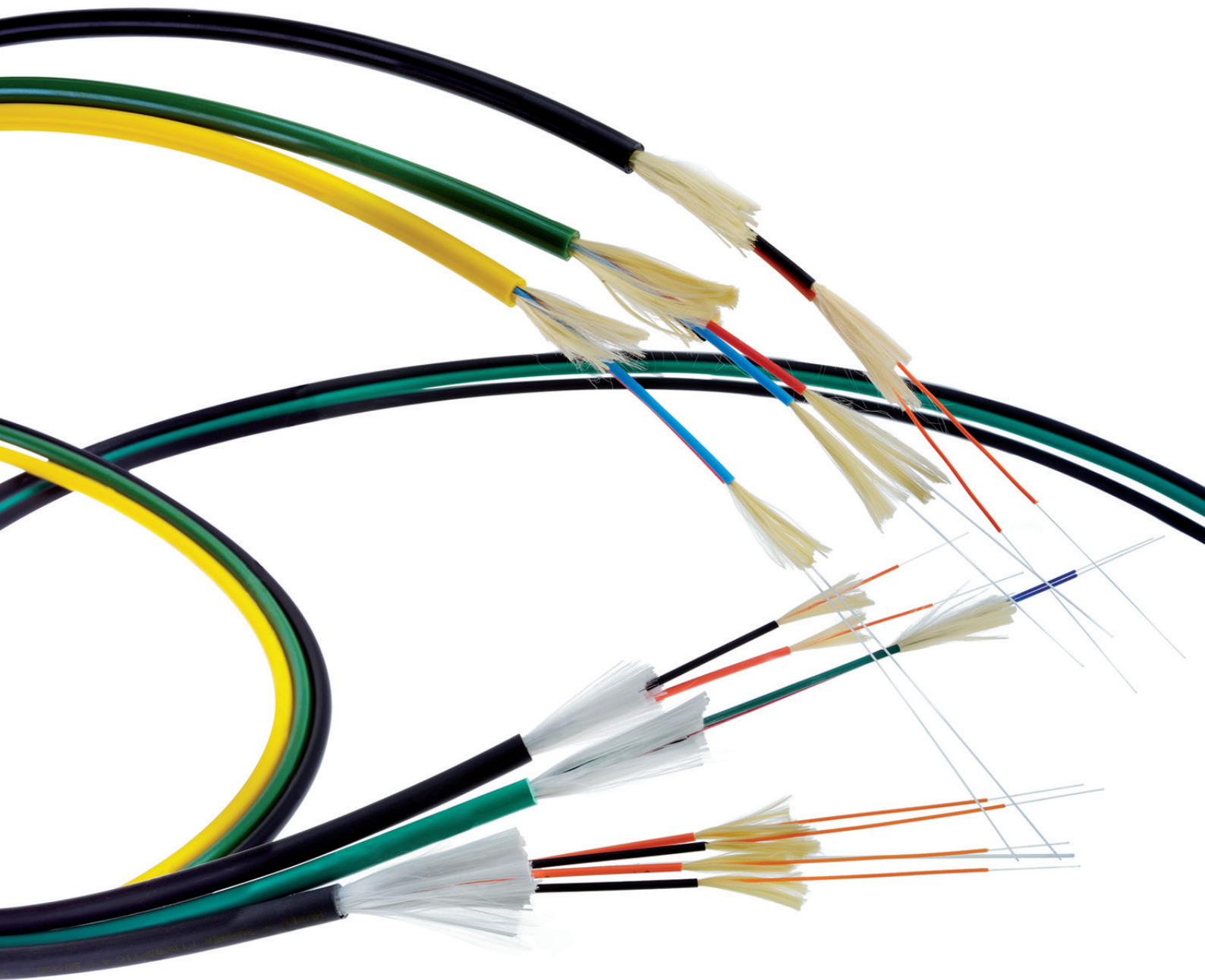

Fiber optics

HUBER+SUHNER provides optical connectivity technology, which is manufactured for the railway industry according to international and european standards. HUBER+SUHNER offers comprehensive solutions for complete fiber optic cabling through the whole train composition including fixed and moved installed cables in indoor and outdoor areas.

The fiber optic products for the railway industry are specially designed to meet fire safety requirements and resist high mechanical strains, big changes of temperature and critical influences like vibration, shock, humidity and UV radiation.

Fiber optic is resistant against electromagnetic interference and voltage peaks - a significant advantage for the transmission of high data rates on railway vehicles.

Further advantages compared to conventional copper connections and other available solutions are the low weight, the compact size and the high data rate.

Cabling systems

Pre-terminated cabling systems for fixed installations in indoor or outdoor areas of railway vehicles guarantee best optical performance as well as a safe, installation friendly and time-saving mounting.



Features

- Fire retardant and halogen free components (RADOX) for compliance to fire safety requirements
- Conduit for additional cable protection
- Customer specific design (length, fiber count, labels, etc.)
- Waterproof and reusable pulling tube
- 100 % tested, ready-to-install

Inter-vehicle fiber optic cable systems that are mounted to the outside of trains (jumpers) require enhanced mechanical and thermal stability. These products are adapted and tailored to suit individual customer requirements.

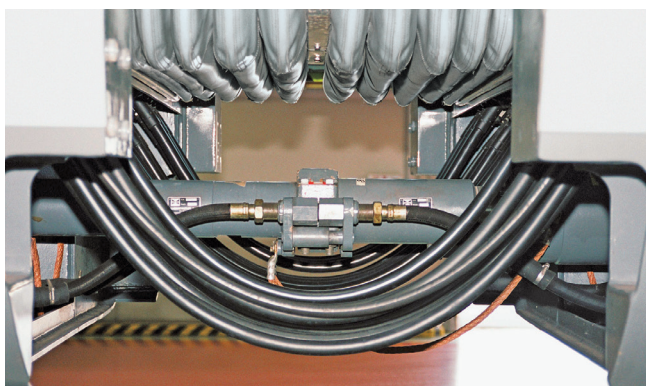

Features

- Long durability in moved applications
- Especially designed with suitable cables
- Conduit for additional cable protection
- Wide choice of connector solutions
- 100 % mechanically and optically tested, ready-to-install
- Ultra low loss variation over millions of movement cycles

Fiber optic cables

Cables for in-carriage installations

The metal free cables fulfill high requirements concerning fire and personal security. All cables are available with singlemode or multimode fibers.

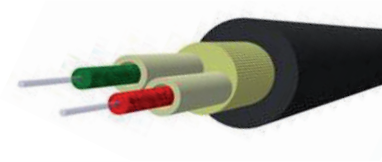

RADOX fiber optic 2 fibers

- 2 optical fibers
- Fire performance according to EN 45545-2
- RADOX EM104 sheath material according to EN 50264-1
- Low bending radius



RADOX fiber optic 12 fibers

- Up to 12 fibers
- Fire performance according to EN 45545-2
- RADOX EM 104 sheath material according to EN 50264-1



Low Smoke Free of Halogen (LSFH) fiber optic 4 fiber

- Up to 4 optical fibers
- Fire performance according to the requirements of London Underground Engineering Standard and BS6853
- Excellent price/fire performance ratio



Fire resistant (FR) breakout cable

- Up to 4 fibers
- Low smoke, halogen free and self-extinguishing
- Fire test with circuit integrity during 180 mn according to EN 50200

Cables for inter-vehicle jumper installations

The metal free fiber optic cables are specifically designed for dynamic applications and offer a high mechanical and dynamic strength.

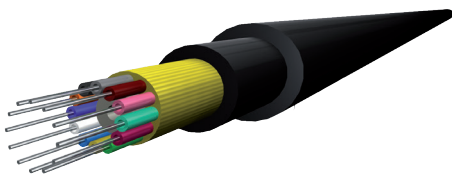

Jumper fiber optic cable

- Up to max. 12 fibers
- Fire performance according to EN 45545-2
- RADOX EM 104J sheath material according to EN 50264-1
- Tested over 4 mio. cycles repeated bending

Fiber optic connectors

Connectors for protected environment

HUBER+SUHNER offers all common standard and „small-form-factor“ connectors. Special types like the LSH (E-2000™) and LX.5 have a multifunctional, automatic metal shutter for dust protection and laser safety.

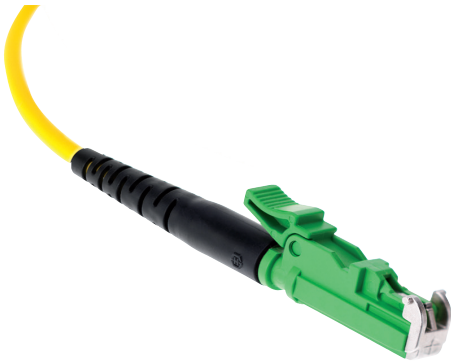

LSH (E-2000™)

- Latched push-pull connector
- Automatic metal shutter in connector and adapter for dust protection and laser safety
- Constant transmission due to long connector guiding
- Mechanical and colour coding of connector and adapter



ST-Security

- Internal suspension for uninterrupted connection
- Compatible to standard ST connectors
- Bayonet nut connector

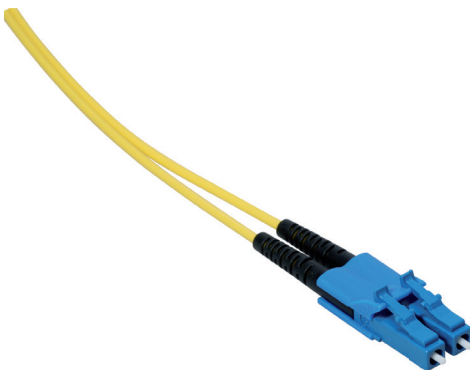

LC-HQ

- Small form factor design for high packing density
- Easy coupling with push-pull
- Best handling with clip
- For connecting transceivers in switches
- Optional LX.5 with automatic dust cap

E-2000™ is manufactured under licence of DIAMOND SA, CH LOSONE

Fiber optic connectors

Connectors for rolling stock environment

The solutions of HUBER+SUHNER are specially designed and tested to resist against highest mechanical and thermic strains in railway vehicles.



Q-ODC®

- 2 channels in singlemode or multimode
- Push-pull coupling mechanism
- Vibration and shock resistant according to IEC 61373
- Secure coupling with two clearly defined mating states
- Protected fiber endfaces
- IP 67 sealed connector
- EMI protected

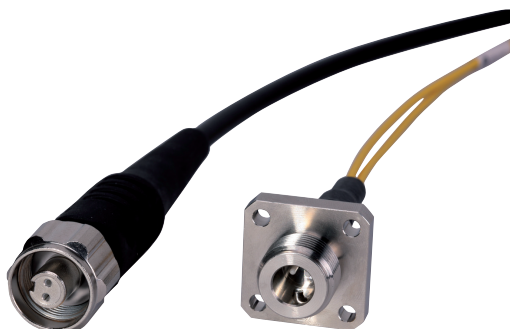

ODC®

- 2 or 4 channels in singlemode or multimode
- Screwed locking mechanism
- Vibration and shock resistant according to IEC 61373
- Easy and secure installation
- Protected fiber endfaces
- IP 68 sealed connector
- EMI protected

For customized cabling systems: other connector types available on request.

Cable and fiber management

HUBER+SUHNER offers special components and solutions for fiber management systems on train vehicles. Special bend radius limiters, cable management elements and patch cord channels guarantee a technically professional and clearly arranged fiber management in the distribution rack.

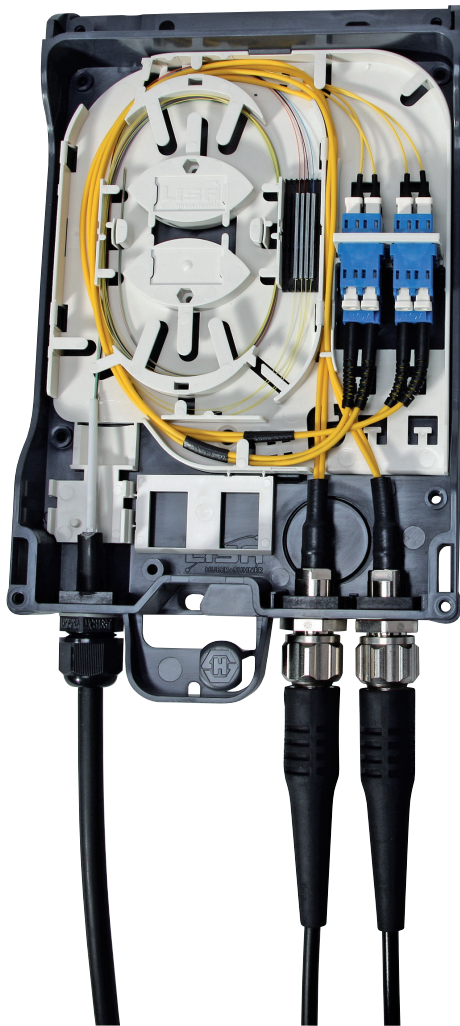

LISA fiber distribution systems

- Compact and robust construction
- For splicing and/or patching
- Optimized cable and fiber management
- Design according to customer requirements
- Compliance of minimal bend radii





Additional information

Delivery spools	200
Guide to installation	202
EMC screened cables	203
Protect your equipment/machinery against interference and failure	205

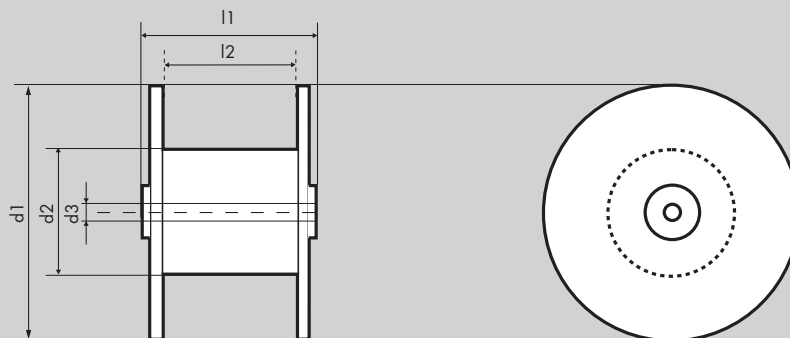
Delivery spools

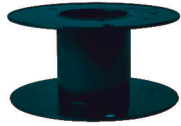
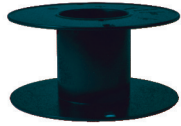

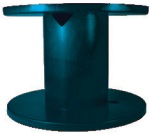
	Spool HS 150	Spool HS 151	Spool HS 200	Spool HS400	Spool HS 401
					
d 1	150	150	195	395	395
d 2	65	65	100	180	180
d 3	60	60	60	60	60
l 1	76	166	250	185	280
l 2	70	160	210	145	240
Tara kg	0.095	0.135	0.480	1.475	1.645

Cable Ø mm	Cable length per delivery m				
1	804	1'837	3'698	11'263	18'642
2	201	459	924	2'816	4'661
3	89	204	411	1'251	2'071
4	50	115	231	704	1'165
5	32	73	148	451	746
6	22	51	103	313	518
7	16	37	75	230	380
8	13	29	58	176	291
9	10	23	46	139	230
10	8	18	37	113	186
11	7	15	31	93	154
12	6	13	26	78	129
13	5	11	22	67	110
14	4	9	19	57	95
15	4	8	16	50	83
16	3	7	14	44	73
17	3	6	13	39	65
18	2	6	11	35	58
19	2	5	10	31	52
20		5	9	28	47
21		4	8	26	42
22		4	8	23	39
23		3	7	21	35
24		3	6	20	32

d1 flange diameter (mm), d2 core diameter (mm), d3 drill hole diameter (mm)
 l1 external width (mm)
 l2 reel width (mm)

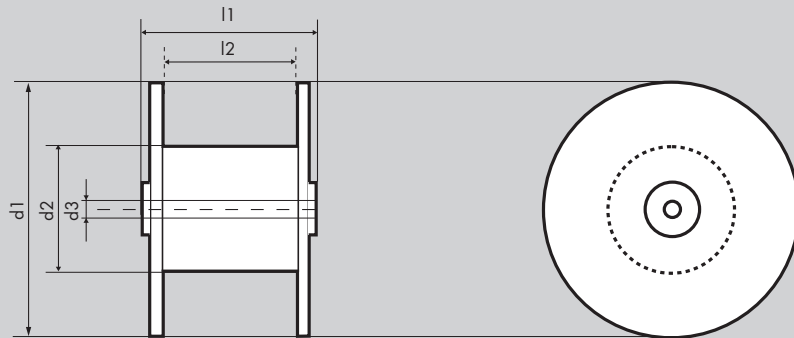

	Spool HS 600	Spool HS 601	Spool HS 800	Spool HS 1200	Reusable NPS coil 250 × 400 (CK2)	Reusable NPS coil 400 × 400 (CK4)
						
d 1	595	595	795	1190	400	400
d 2	350	250	450	600	208 to 260	176 to 260
d 3	80	80	80	80	80	80
l 1	500	500	750	790	313	463
l 2	430	430	620	650	250	400
Tara kg	7.460	7.150	18.875	64.200	2.4	2.7

Cable Ø mm	Cable length per delivery m				For details about length, instruction manual and accessories ask for separate documentation.
1	62'553	78'763	167'325	431'319	
2	15'638	19'691	41'831	107'830	
3	6'950	8'751	18'592	47'924	
4	3'910	4'923	10'458	26'957	
5	2'502	3'151	6'693	17'253	
6	1'738	2'188	4'648	11'981	
7	1'277	1'607	3'415	8'802	
8	977	1'231	2'614	6'739	
9	772	972	2'066	5'325	
10	626	788	1'673	4'313	
11	517	651	1'383	3'565	
12	434	547	1'162	2'995	
13	370	466	990	2'552	
14	319	402	854	2'201	
15	278	350	744	1'917	
16	244	308	654	1'685	
17	216	273	579	1'492	
18	193	243	516	1'331	
19	173	218	464	1'195	
20	156	197	418	1'078	
21	142	179	379	978	
22	129	163	346	891	
23	118	149	316	815	
24	109	137	290	749	

Guide to installation

Information regarding selection and installation of cables including current ratings can be found in EN 50355 and EN 50343.

Smallest acceptable bending radii

Installation method	For RADOX signal and power cables		For RADOX FR und databus cables	
	cable diameter		cable diameter	
	D < 12 mm	D > 12 mm	D < 12 mm	D > 12 mm
- Fixed installation	3 × D	4 × D	5 × D	6 × D
- Flexible application ¹⁾	4 × D	5 × D	--	
- Constantly moved	10 × D	10 × D	--	

¹⁾ Correctly installed wires and cables which will be moved approx. 5 to 10 times per day (bending radius 90 °).

Conditions

The specified bending radii require a careful and proper handling using proven fastening technologies.

Cable lifetime reducing factors are:

- Number of bendings
- Tight bending radius
- High application temperature
- Bending at low temperatures
- Mechanical stress and improper installation

Allowable tensile stress

For installation cables by pulling on the conductor, or by drawing sleeve, the following max. pulling force (P) is allowed:

$$P = 50 \times A \text{ (N)}$$

$$A = \text{Sum of conductor cross-section (mm}^2\text{)}$$

Current carrying capacity

For the selection of the cable cross-section with regard to the current rating for continuous operation HUBER+SUHNER provides a product specific documentation.

For further notes on installation, please see the relevant individual flyers/data sheets.

EMC screened cables

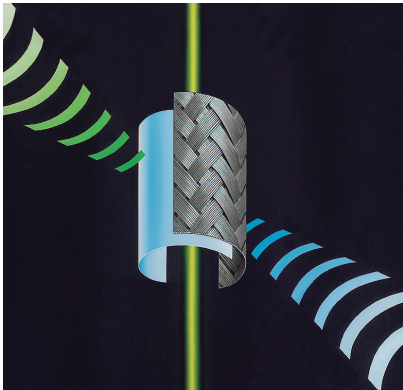

The screening of cables can be described by the two coupling quantities of transfer impedance Z_T and transfer admittance Y_T . Both coupling quantities are basically a function of the geometry and the environment; depending on the specific application and requirements, the coupling quantities can be optimised for a given cable.

EMI	electromagnetic interference
EMP	electromagnetic pulse
ESD	electrostatic discharge
LEMP	lightning electromagnetic pulse
NEMP	nuclear electromagnetic pulse
TEMPEST	tap-proofness (eaves-dropping protection)
NEXT	near-end crosstalk

With HUBER+SUHNER, your screening problems will end.

We can ensure this thanks to the vast experience accumulated in this field responding to every kind of customer need and collaborating continuously with research institutes.

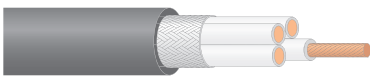

Measurement engineering at HUBER+SUHNER

Complies with the following standards:
IEC 96-1 and 46 A/DIN 47250/
VG 95373/CCITT/...

Screenings for all EMC requirements

HUBER+SUHNER designs, optimizes and produces products for a wide variety of performance classes. These products are implemented using different braids, foils, high-permeability intermediate layers, microwave-absorbing and semi-conducting layers, mixed screens, etc.

EMC screened cables

Screened cables from single braid to superscreen

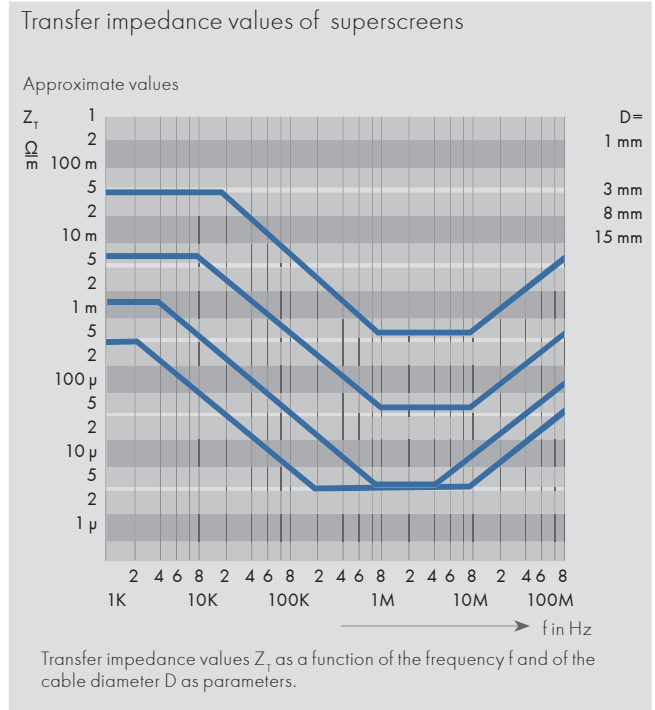
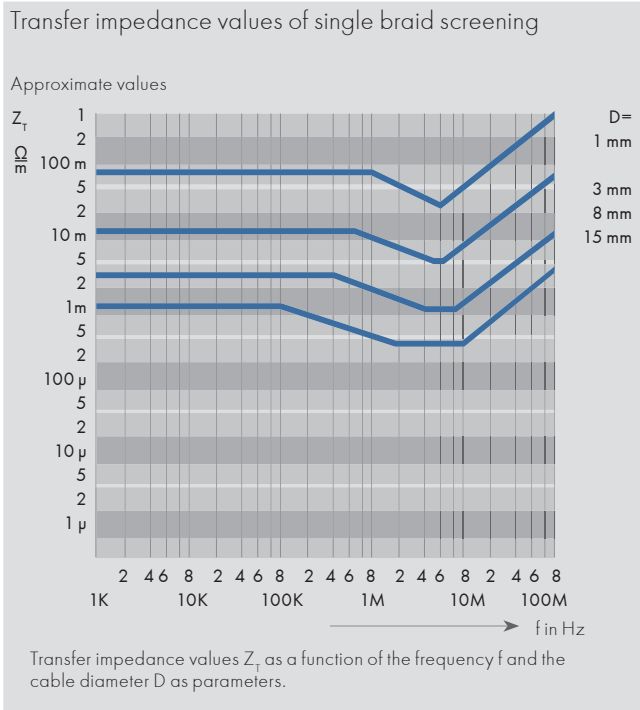

The transfer impedance Z_T (also called «coupling resistance») refers to the relationship between the current in one wire and the longitudinal voltage it induces in the other wire (ohmic-inductive coupling).

The transfer admittance Y_T refers to the relationship between the voltage in one wire and the leak current it induces in the other line (capacitive coupling).

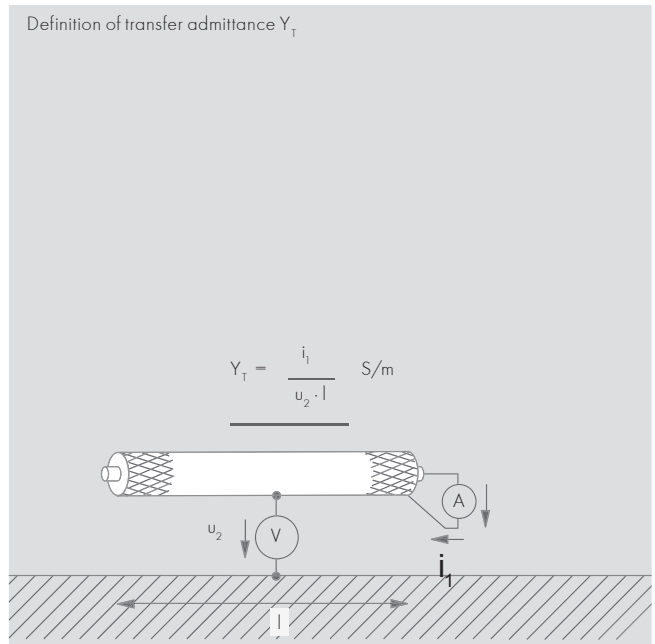
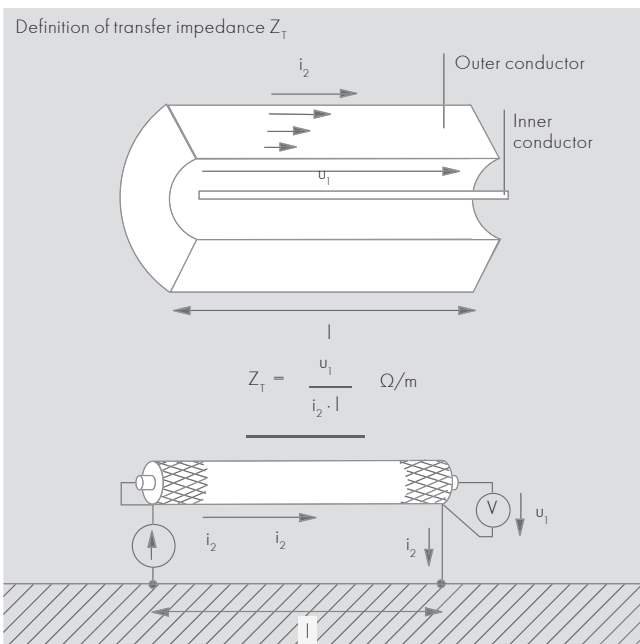

The cable together with its surroundings form a three-conductor system. It consists of two coupled conductors with one common conductor (screen).

Transfer impedance Z_T and transfer admittance Y_T are cable quantities which are always defined in conjunction with the surroundings of the cable and the construction of the cable itself.

Protect your equipment/machinery against interference and failure

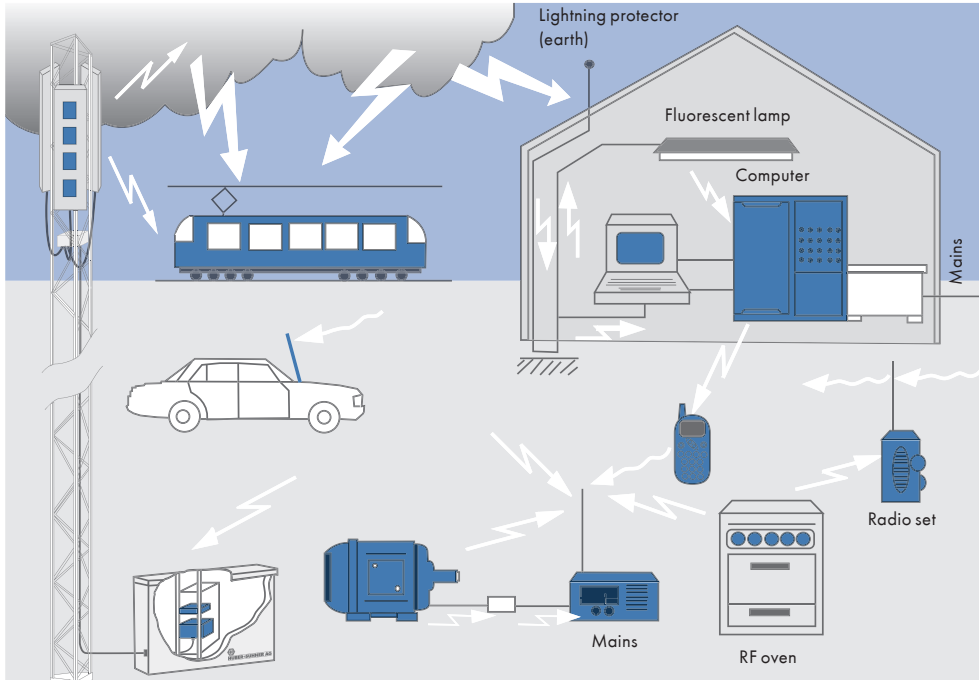

The situation

Environmental pollution is a modern buzzword. But do you ever think of it as «pollution» by electromagnetic radiation, by «electrosmog»??

Your problem

Only when machinery starts to fail and plant operation is disrupted do the people in charge start thinking. But things don't have to reach that point. Non-screened cables act in the same way as antennas, attracting interference from the outside or radiating it.

Our solution

Copper braids prevent dangerous interferences with cables. At the same time, the interference radiated by the cable is reduced. Our solution consists not only in the specification of a degree of coverage. HUBER+SUHNER also defines the effectiveness of a copper braid as a measurable quantity. This noise immunity is expressed by the transfer impedance (coupling resistance) at a given frequency (MHz) in Ω/m .

Optimised, high grade screening

Optimised screening braids enable even the most intractable screening problems to be solved. And in screening cables, we take care to ensure that performance of the screened cables will not be significantly affected in terms of flexibility, workability, weight and dimensions.

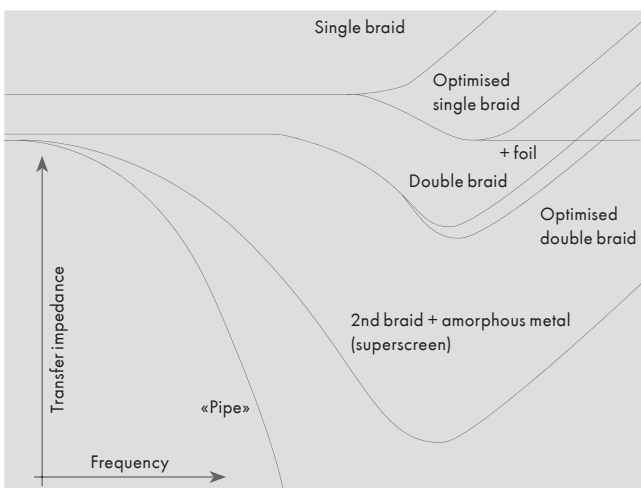

HUBER+SUHNER AG
Low Frequency Division
Tumbelenstrasse 20
8330 Pfäffikon ZH
Switzerland
Phone +41 44 952 2211
hubersuhner.com

HUBER+SUHNER is certified according to EN(AS) 9100, ISO 9001, ISO 14001, ISO/TS 16949 and IRIS.

Waiver

Fact and figures herein are for information only and do not represent any warranty of any kind.